

ΚΛΙΜΑΤΙΣΤΙΚΑ ΣΥΣΤΗΜΑΤΑ
AIR CONDITIONING SYSTEMS

Models: O1MVI-09WFR/O1MVO-09
O1MVI-12WFR/O1MVO-12
O1MVI-18WFR/O1MVO-18
O1MVI-24WFR/O1MVO-24

 **inventor**[®]
Your-conditions

Wall Mounted Unit
User's Manual
Επιτοίχια Μονάδα
Εγχειρίδιο Χρήστη

Split de perete
Manual de utilizare

Σας ευχαριστούμε που επιλέξατε τη μονάδα κλιματισμού της INVENTOR. Για τη σωστή χρήση της μονάδας, παρακαλούμε διαβάστε προσεκτικά το παρόν εγχειρίδιο και φυλάξτε το για αναφορά στο μέλλον.

Thank you for choosing INVENTOR air conditioning system. For correct use of this unit, please read this manual carefully and keep it for future reference.



English/Ελληνικά/ Română

 **inventor**[®]
Your-conditions

CONTENTS

SAFETY PRECAUTIONS

| | |
|---------------|---|
| Warning | 3 |
| Caution | 4 |

NAMES OF PARTS

| | |
|----------------------|---|
| Indoor unit | 5 |
| outdoor unit | 5 |
| Indication lamp..... | 5 |

OPERATING INSTRUCTIONS

| | |
|-------------------------------------|---|
| Special functions | 6 |
| Operating temperature..... | 7 |
| Manual operation | 7 |
| Airflow direction control | 8 |
| How the air conditioner works | 9 |

CARE AND MAINTENANCE

| | |
|---|----|
| Before maintenance..... | 10 |
| Cleaning the unit..... | 10 |
| Cleaning the air filter and air freshening filter | 10 |
| Replacement of the air filter and air freshening filter | 11 |
| Preparation for extended non-operation..... | 11 |
| Pre-season inspection..... | 11 |

TROUBLESHOOTING TIPS

| | |
|---|----|
| Normal function of the air conditioner..... | 12 |
| Troubleshooting guide | 14 |

When using this air conditioner in the European countries, please read the following information:

- This appliance can be used by children aged from 8 years and above and persons with reduced physical, sensory or mental capabilities, or lack of experience and knowledge if they have been given supervision or instruction concerning use of the appliance in a safe way and understand the hazards involved. Children shall not play with the appliance. Cleaning and user maintenance shall not be made by children without supervision.

DISPOSAL: Do not dispose of this product as unsorted municipal waste. Collection of such waste separately for special treatment is necessary.

It is prohibited to dispose of this appliance in domestic household waste. For disposal, there are several possibilities:

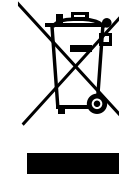

- A) The municipality has established collection systems, where electronic waste can be disposed of at least free of charge to the user.
- B) When buying a new product, the retailer will take back the old product at least free of charge.
- C) The manufacturer will take back the old appliance for disposal at least free of charge to the user.
- D) As old products contain valuable resources, they can be sold to scrap metal dealers.

Wild disposal of waste in forests and landscapes endangers your health when hazardous substances leak into the ground-water and find their way into the food chain.





SAFETY PRECAUTIONS

To prevent injury to the user or other people and property damage, the following instructions must be followed. Incorrect operation due to ignoring of instructions may cause harm or damage. The seriousness is classified by the following indications.

| | |
|--|--|
|  WARNING | This symbol indicates the possibility of death or serious injury. |
|  CAUTION | This symbol indicates the possibility of injury or damage to property. |

■ Meanings of symbols used in this manual are as shown below.

| | |
|---|--|
|  | Strictly prohibited. |
|  | Be sure to follow the instructions. |

WARNING



- Do not extend the cable and never use multiple plugs. A poor electrical connection, poor insulation or voltage which is higher than permitted can cause fire.
- Do not expose your body directly to the cool air for prolonged period.
- Never poke fingers, sticks or other objects in the air inlet and outlet vents.
- Never attempt to repair, relocate, modify the air conditioner yourself. Always contact your service partner if it requires.
- Never pull the plug out by pulling on the cable. Hold the plug firmly and pull it out of the plug socket, otherwise there is a risk of damaging the cable.
- Do not operate your air conditioner in a wet room such as a bathroom or laundry room.



- Remove all dirt from the power plug and plug it firmly. Soiled plugs can cause fire or an electric shock.
- In the event of any abnormalities such as smell of burning, immediately switch off the device and pull the plug. Contact your service partner.
- Always switch off the device and pull the plug before you start to clean it.
- Use specified power cord.
- Contact the authorized installer for installation of this unit.
- Contact an authorized service technician for repair or maintenance of this unit.
- This appliance is not intended for use by persons (including children) with reduced physical, sensory or mental capabilities, or lack of experience and knowledge, unless they have been given supervision or instruction concerning use of the appliance by a person responsible for their safety.
- Children should be supervised to ensure that they do not play with the air conditioner.

SAFETY PRECAUTIONS

CAUTION



- Never actuate any switches with a wet hand. It may cause an electric shock. Never use the device for any other purpose than the intended use. Never place food, precision instruments, plants, animals, paint, etc. on the unit.
- Do not expose plants or animals directly to the air flow.
- Never clean the air conditioner with water. Never use combustible cleaning agents as these could cause a fire or deformation.
- Never place any burning objects close to the device if they could be directly affected by the emitted air.
- Never step onto the outdoor device and never place anything on it. Never use an unsteady or rusty base.
- Never install the air conditioner in places where combustible gas can be emitted. Emmitted gas may collect and cause an explosion.
- Never allow the air conditioner to run for too long with the doors or windows open, or if the humidity is very high.



- If the air conditioner is to be used in conjunction with other heaters, the air should be refreshed periodically, otherwise there is a risk of lack of oxygen.
- Always pull out the power plug if the unit is not going to be used for any lengthy period of time. Collections of dust can cause fire.
- Always switch off the air conditioner and pull out the power plug during a storm. Electrical parts may get damaged.
- Check that the drainage line is correctly connected. If not, water will escape.
- Check that the condensation water can run off unhindered. It may cause water damage if the condensation water cannot run off properly.
- The air conditioner must be earthed in accordance with the local codes.
- For electrical safety purposes we recommend that you install an earth-leakage circuit-breaker.
- If the power cord is damaged, it must be replaced by the manufacturer, its service agent or similiary qualified persons in order to avoid a hazard.

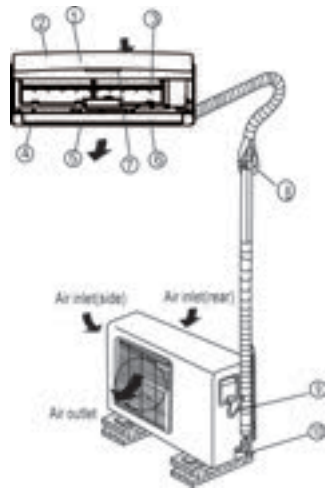

Names of parts

Indoor unit

1. Front panel
2. Air inlet
3. Air filter
4. Air outlet
5. Horizontal air flow grille
6. Vertical air flow louver(inside)
7. Display panel

Outdoor unit

8. Connecting pipe
9. Connecting cable
10. Stop valve

NOTE:

All the pictures in this manual are for explanation purposes only. The actual shape of the indoor unit you purchased may be slightly different from front panel and display window. The actual shape shall prevail.

Indication lamp



(A)

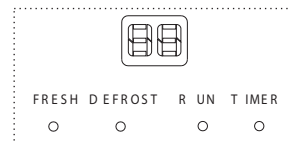

(B)

Indication lamp

FRESH indication lamp(optional)
Lights up when Clean Air feature is activated.

DEFROST indication lamp
(Enabled on cooling & heating models only):
Lights up when the air conditioner starts defrosting automatically or when the warm air control feature is activated in heating operation.



TEMPERATURE indication lamp
• Displays the temperature settings when the air conditioner is operational.
• Displays the malfunction code when fault occurs.

RUN indication lamp
This lamp illuminates when the air conditioner is in operation.

TIMER indication lamp
Lights up during Timer operation.

Special functions

Refrigerant Leakage Detection

With this new technology, the display area will appear 'EC' and the indication lamps continue flashing when the outdoor unit detects refrigerant leakage.

Louver Angle Memory Function(optional):

Within the scope of safety angle, it will memorize the open angle of horizontal louver. If it exceeds, it will memorize the boundary of safety angle. In the following circumstances, it will return to standard angle: 1) pressing the manual switch, 2)unplug and then plug in the machine. So we strongly suggest that the open angle of the horizontal louver should not be set too small, in case the condensed water forms and drops from the horizontal louver.

SELF CLEAN function (Optional)

- Function used after the Shut Down of cooling operation to clean the Evaporator and keep it as fresh for the next operation.
- The unit will operate as following sequence : FAN ONLY mode at Low fan speed--Heating operation with LOW fan speed(applicable to cooling & heating modes only) ---FAN ONLY operation--Stop Operation---Turn off.
Note:
• This function is only available under COOL(AUTO COOL, FORCED COOL) and DRY mode.
• Before select the function, it is recommended to run the air conditioner under Cooling operation for about half an hour. Once the Self Clean function is activated, all TIMER setting will be cancelled.
- During Self Clean operation, when press the SELF CLEAN button on the remote controller again will stop the operation and turn off the unit automatically.

CLEAN AIR function(on some models)

Improving the quality of indoor air is one of the purposes of an air conditioner. This air conditioner is equipped with ionizer or Plasma Dust Collector(Depending on specific configuration of the model). With the anions generated by Ionizer, the air circulation of the air conditioner fills the room with refreshing, natural and healthy air. The Plasma Dust Collector generates a high voltage ionization zone, through which the air is converted to plasma. Inside the air most of the dust, smoke, and pollen particles are captured by the electrostatic filter.

Anti-mildew function (Optional)

- When turns off the unit on COOL, DRY, AUTO (Cool) mode, the air conditioner will continue operating for about 7-10 minutes (depending on models) at LOW fan speed. If turns off on HEAT mode, the unit will continue operating for about 30 seconds at LOW fan speed. This will help to dry up the condensed water inside the evaporator, and prevent the breeding of mildew.
- Under Anti-mildew operation, do not restart the air conditioner until the unit is completely off.

OPERATING INSTRUCTIONS

NOTE: This manual does not include Remote Controller Operations, see the <<Remote Controller Instruction>> packed with the unit for details.

Operating temperature

| Mode | Cooling operation | Heating operation | Drying operation |
|---------------------|---|--------------------------|--------------------------|
| Room temperature | 17°C~32°C (62°F~90°F) | 0°C~30°C (32°F~86°F) | 10°C~32°C (50°F~90°F) |
| Outdoor temperature | 0°C~50°C (32°F~122°F) | -15°C~30°C (5°F~86°F) | 0°C~50°C (32°F~122°F) |
| | (-15°C~50°C / 5°F~122°F: For the models with low temperature cooling system) | | |

NOTE:

- Optimum performance will be achieved within these operating temperatures. If air conditioner is used outside of the above conditions, certain safety protection features might come into operation and cause the unit to function abnormally.
 - If the air conditioner runs for a long time in cooling mode and the humidity is high (over 80%), condensed water may drip out of the unit. Please set the vertical air flow louver to its maximum angle (vertically to the floor), and set HIGH fan mode.
- Suggestion:** For the unit adopts an Electric Heater, when the outside ambient temperature is below 0°C(32°F), we strongly recommend you to keep the machine plugged in order to guarantee it running smoothly.

Manual operation

Units are equipped with a switch to run emergency operation mode. It can be accessed by opening the front panel. This switch is used for manual operation in case the remote controller fails to work or maintenance necessary.

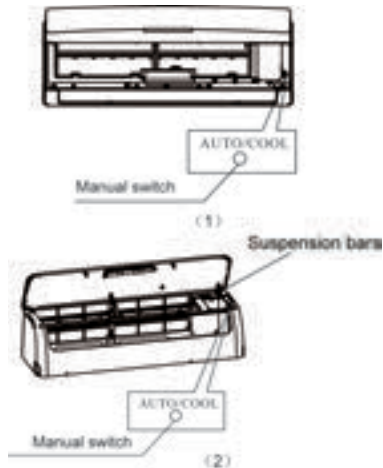

- NOTE:** The unit must be turned off before operating the manual control button. If the unit is operational, continue pressing the manual control button until the unit is off.
- Open and lift the front panel up to an angle until it remains fixed with a clicking sound. For some models, please use suspension bars to prop up the panel.
 - One press of the manual control switch will lead to the forced AUTO operation. If press the switch twice within five seconds, the unit will operate under forced COOL operation.
 - Close the panel firmly to its original position.

CAUTION:

- This switch is used for testing purposes only. You had better not choose it.
- To restore the remote controller operation, use the remote controller directly.

7

OPERATING INSTRUCTIONS

Airflow direction control

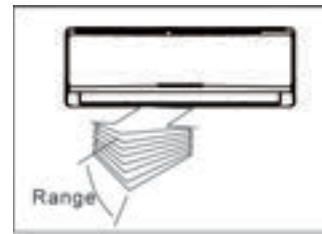

Adjust the air flow direction properly, otherwise it might cause discomfort or cause uneven room temperatures.
Adjust the horizontal louvers using the remote controller.
Adjust the vertical louvers manually.

To set the vertical air flow (Up-Down) direction. Perform this function while the unit is in operation. Use the remote controller to adjust the air flow direction. The horizontal louvers can be moved at a range of 6° for each press or swing up and down automatically. Please refer to the "REMOTE CONTROLLER OPERATION MANUAL" for details.

- To set the horizontal air flow direction (left - right)
 - Move the deflector rod manually to adjust the air flow in the direction you prefer.
- IMPORTANT:** Do not put your fingers into the panel of blower and section side. The high-speed fan inside may cause danger.

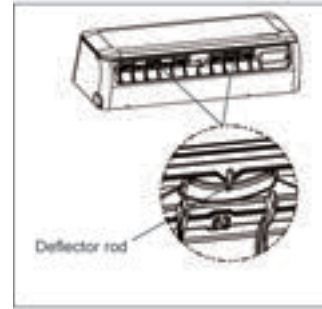

CAUTION

- Do not operate the air conditioner for long periods with the air flow direction set downward in cooling or dehumidifying mode. Otherwise, condensation may occur on the surface of the horizontal louvers causing moisture to drop on to the floor or on furnishings.
- When the air conditioner is started immediately after it was stopped, the horizontal louvers might not move for approximately 10 seconds.
- Open angle of the horizontal louvers should not be set too small, as COOLING or HEATING performance may be impaired due to too restricted air flow area.
- Do not move the horizontal louvers manually, otherwise the horizontal louvers will be out of sync. Please cease operating, unplug power for a few seconds then restart the air conditioner.
- Do not operate unit with horizontal louvers in closed position.

8

How the air conditioner works

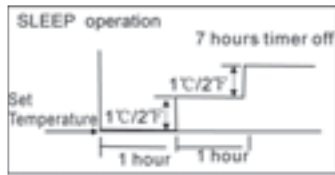

Cooling

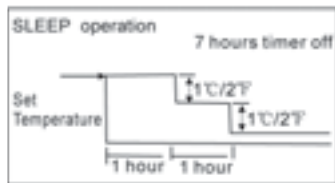

Heating

AUTO operation

- When you set the air conditioner in AUTO mode, it will automatically select cooling, heating (cooling/heating models only), or fan only operation depending on set temperature and the room temperature.
- The air conditioner will control room temperature automatically to the temperature point you set.
- If you feel uncomfortable in the AUTO mode, you can set your desired temperature.

SLEEP operation

When you push SLEEP button on remote controller during cooling, heating (cooling & heating models only), or AUTO operation, the air conditioner will automatically increase (cooling) or decrease (heating) 1°C/2°F per hour for the first 2 hours, then hold steadily for the next 5 hours after that it will shut off. This mode saves you energy and brings you comfort at night.

DRYING operation

- The fan speed will be automatically controlled under dry operation.
- During the dry operation, if the room temperature is lower than 10°C(50°F), the compressor stops operation and restarts until the room temperature is above 12°C(54°F).

Optimal operation

- To achieve optimal performance, please note the following:
- Adjust the air flow direction correctly so that it is not forwards people.
- Adjust the temperature to achieve the highest comfort level. Do not adjust the unit to excessive temperature levels.
- Close doors and windows on COOL or HEAT modes or performance may be reduced.
- Use TIMER ON button on the remote controller to set a time you want to start your air conditioner.
- Do not put any object near air inlet or air outlet, as the efficiency of the air conditioner may be reduced and the air conditioner may stop running.
- Clean the air filter periodically, otherwise cooling or heating performance may be reduced. Do not operate unit with horizontal louvers in closed position.

Care and Maintenance

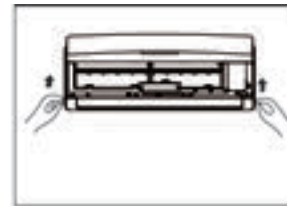

Before maintenance

- Turn the power off before cleaning. To clean, wipe with a soft, dry cloth. Do not use bleach or abrasives.
- NOTE: Power supply must be disconnected before cleaning the indoor unit.

CAUTIONS

- A cloth dampened with cold water may be used on the indoor unit if it is very dirty. Then wipe it with a dry cloth.
- Do not use a chemically treated cloth or duster to clean the unit.
- Do not use benzene, thinner, polishing powder, or similar solvents for cleaning. These may cause the plastic surface to crack or deform.
- Never use water hotter than 40°C/104°F to clean the front panel, it could cause deformation of the louver.

Cleaning the unit

wipe the unit with a soft dry cloth only. If the unit is very dirty, wipe it with a cloth soaked in warm water.

Cleaning the air filter and air freshening filter

- A clogged air filter reduces the cooling efficiency of this unit. Please clean the filter once every 2 weeks.
1. Lift the indoor unit panel up to an angle until it stops with a clicking sound. For some models please use supports on bars to prop up the panel.
 2. Take hold of the handle of the air filter and lift it up slightly to take it out from the filter holder, then pull it downwards.
 3. Remove the AIR FILTER from the indoor unit. Clean the AIR FILTER once two weeks. Clean the AIR FILTER with a vacuum cleaner or water, then dry it up in a cool place.
 4. Remove the Air Freshening Filter from its supporting frame (on some models).
 - Clean the air freshening filter at least once a month, and replace it every 4-5 months.
 - Clean it with a vacuum cleaner, then dry it in a cool place.



5. Insert all the air freshening filter back into position.
6. Insert the upper portion of air filter back into the unit, taking care that the left and right edges line up properly and place filter into position.

Replacement of air filter and air freshening filter

1. Remove the air filter.
2. Remove the air freshening filter.
3. Insert all a new air freshening filter.
4. Reinsert all the air filter and secure it by closing the front panel.



Preparation for extended non-operation

If you plan to idle the unit for a long time, perform the following:

- (1) Clean the indoor unit and filters
- (2) Operate the fan for about half a day to dry the inside of the unit.
- (3) Stop the air conditioner and disconnect power.
- (4) Remove the batteries from the remote controller. The outdoor unit requires periodic maintenance and cleaning. Do not attempt to do this yourself. Contact your dealer or service provider.

Pre-season inspection

- Check that the wiring is not broken off or disconnected.
- Clean the indoor unit and filters
- Check that the air filter is inserted.
- Check if the air outlet or inlet is blocked after the air conditioner has not been used for a long time.

⚠ Caution

- Do not touch the metal parts of the unit when removing the filter. Injuries can occur when handling sharp metal edges
- Do not use water to clean inside the air conditioner. Exposure to water can destroy the insulation, leading to possible electric shock
- When cleaning the unit, first make sure that the power and circuit breaker are turned off.
- Do not wash air filter with hot water at more than 40°C/104°F. Shake off moisture completely and dry it in the shade. Do not expose it directly to the sun, it may shrink

Normal function of the air conditioner

The following events may occur during normal operation.

1. Protection of the air conditioner.
 - Compressor protection
 - The compressor can't restart for 3-4 minutes after it stops.
 - Anti-cold air (Cooling and heating models only)
 - The unit is designed not to blow cold air on HEAT mode, when the indoor heat exchanger is in one of the following three situations and the set temperature has not been reached.
 - A) When heating has just started.
 - B) Defrosting.
 - C) Low temperature heating.
 - The indoor or outdoor fan stop running when defrosting (Cooling and heating models only).
 - Defrosting (Cooling and heating models only)
 - Frost may be generated on the outdoor unit during heat cycle when outdoor temperature is low and humidity is high resulting in lower heating efficiency of the air conditioner.
 - During this condition air conditioner will stop heating operation and start defrosting automatically.
 - The time to defrost may vary from 4 to 10 minutes according to the outdoor temperature and the amount of frost built up on the outdoor unit.
2. A white mist coming out from the indoor unit
 - A white mist may generate due to a large temperature difference between air inlet and air outlet on COOL mode in an indoor environment that has a high relative humidity.
 - A white mist may generate due to moisture generated from defrosting process when the air conditioner restarts in HEAT mode operation after defrosting.
3. Low noise of the air conditioner
 - You may hear a low hissing sound when the compressor is running or has just stopped running. It is the sound of the refrigerant flowing or coming to a stop.
 - You can also hear a low "squeak" sound when the compressor is running or has just stopped running. This is caused by heat expansion and cold contraction of the plastic parts in the unit when the temperature is changing.
 - A noise may be heard due to louver restoring to its original position when power is turned on.
4. Dust is blown out from the indoor unit.

This is a normal condition when the air conditioner has not been used for a long time or during first use of the unit.
5. A peculiar smell comes out from the indoor unit.

This is caused by the indoor unit giving off smells permeated from building material, from furniture, or smoke.
6. The air conditioner turns to FAN only mode from COOL or HEAT (For cooling and heating models only) mode.

When indoor temperature reaches the temperature setting on air conditioner, the compressor will stop automatically, and the air conditioner turns to FAN only mode. The compressor will start again when the indoor temperature rises on COOL mode or falls on HEAT mode (For cooling and heating models only) to the set point.

TROUBLESHOOTING TIPS

7. The air conditioner runs Anti-mildew function after turning off the unit.

When turning off the unit under COOL(AUTO COOL, FORCED COOL) and DRY mode, the air conditioner will run Anti-mildew function for 7-10 minutes, if turns off on HEAT mode, the unit will continue operating for about 30 seconds at LOW fan speed, then stop the operation and turn off the unit automatically.

8. Dripping water may generate on the surface of the indoor unit when cooling in a high relative humidity (relative humidity higher than 80%). Adjust the horizontal louver to the maximum air outlet position and select HIGH fan speed.

9. Heating mode (For cooling and heating models only)

The air conditioner draws in heat from the outdoor unit and releases it via the indoor unit during heating operation. When the outdoor temperature falls, heat drawn in by the air conditioner decreases accordingly. At the same time, heat loading of the air conditioner increases due to larger difference between indoor and outdoor temperature. If a comfortable temperature can't be achieved by the air conditioner, we suggest you use a supplementary heating device.

10. Auto-restart function

- Power failure during operation will stop the unit completely.
- For the unit without Auto-restart feature, when the power restores, the OPERATION indicator on the indoor unit starts flashing. To restart the operation, push the ON/OFF button on the remote controller. For the unit with Auto-restart feature, when the power restores, the unit restarts automatically with all the previous settings preserved by the memory function.

TROUBLESHOOTING TIPS

Troubleshooting guide

| | |
|--|--|
| If one of the following faults occurs, stop the air conditioner immediately, disconnect the power and then connect it in again. If the problem still exists, disconnect the power and contact the nearest customer service center. | |
| Trouble | OPERATION indicator or other indicators continue flashing. |
| | Fuse blows frequently or circuit breaker trips frequently. |
| | Other objects or water fall into the air conditioner. |
| | The remote controller won't work or works abnormally. |
| If one of the following code appears on the display area : E0,E1,E2,E3.....or P0,P1,P2,P3..... | |

| Malfunctions | Cause | What should be done? |
|---|---|--|
| Unit does not start | Power cut | Wait for power to be restored. |
| | Unit may have become Unplugged. | Check that plug is securely in wall receptacle. |
| | Fuse may have blown. | Replace the fuse. |
| | Battery in Remote controller may have been exhausted. | Replace the battery. |
| | The time you have set with timer is incorrect. | Wait or cancel timer setting. |
| Unit not cooling or heating (Cooling/ heating models only) room very well while air flowing out from the air conditioner | Inappropriate temperature setting. | Set temperature correctly. For detailed method please refer to "Using remote control" section. |
| | Air filter is blocked. | Clean the air filter. |
| | Doors or Windows are open. | Close the doors or windows. |
| | Air inlet or outlet of indoor or outdoor unit has been blocked. | Clear obstructions away first, then restart the unit. |
| | Compressor 3 minutes protection has been activated. | Wait. |
| If the trouble has not been corrected, please contact a local dealer or the nearest customer service center. Be sure to inform them of the detailed malfunctions and unit model number. | | |

**Notes: Do not attempt to repair the unit yourself.
Always consult an authorized service provider.**

NOTES:

Activate your warranty.....

in **5**
simple
steps!



Scan here for the
warranty form

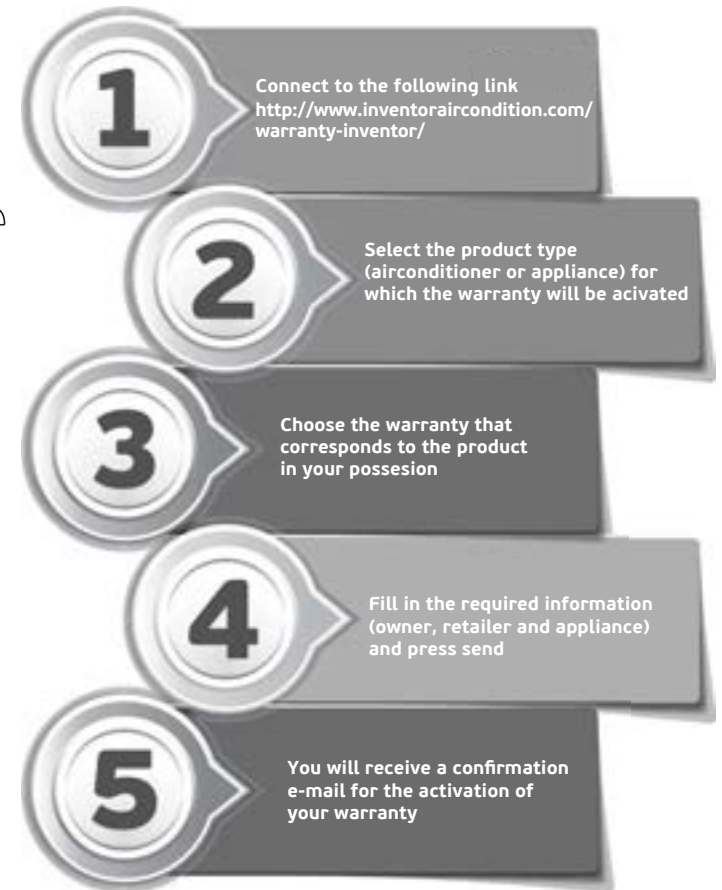

For the electronic
warranty submission
please type the following link

**[http://www.
inventoraircondition.com/
warranty-inventor/](http://www.inventoraircondition.com/warranty-inventor/)**

ΠΕΡΙΕΧΟΜΕΝΑ

ΟΔΗΓΙΕΣ ΑΣΦΑΛΕΙΑΣ

| | |
|---------------------|---|
| Προειδοποίηση | 3 |
| Προσοχή | 4 |

ΠΕΡΙΓΡΑΦΗ ΚΑΘΕ ΕΞΑΡΤΗΜΑΤΟΣ

| | |
|---------------------------|---|
| Εσωτερική μονάδα | 5 |
| Εξωτερική μονάδα | 5 |
| Ενδεικτικές λυχνίες | 5 |

ΟΔΗΓΙΕΣ ΛΕΙΤΟΥΡΓΙΑΣ

| | |
|--|---|
| Ειδικές λειτουργίες | 6 |
| Θερμοκρασία λειτουργίας | 7 |
| Χειροκίνητη λειτουργία | 7 |
| Ρύθμιση της κατεύθυνσης του αέρα | 8 |
| Πως λειτουργεί το κλιματιστικό | 9 |

ΦΡΟΝΤΙΔΑ ΚΑΙ ΣΥΝΤΗΡΗΣΗ

| | |
|---|----|
| Πριν τη συντήρηση | 10 |
| Καθαρισμός της μονάδας | 10 |
| Καθαρισμός των φίλτρων | 10 |
| Αντικατάσταση των φίλτρων | 11 |
| Προετοιμασία για το τέλος της περιόδου χρήσης | 11 |
| Έλεγχος πριν την έναρξη περιόδου χρήσης | 11 |

ΑΝΤΙΜΕΤΩΠΙΣΗ ΠΡΟΒΛΗΜΑΤΩΝ

| | |
|---|----|
| Κανονική λειτουργία της κλιματιστικής μονάδας | 12 |
| Οδηγός αντιμετώπισης προβλημάτων | 14 |

Όταν χρησιμοποιείτε το κλιματιστικό στην Ευρωπαϊκή Ένωση, παρακαλούμε διαβάστε τα παρακάτω:

- Αυτή η μονάδα μπορεί να χρησιμοποιηθεί από άτομα πάνω από 8 ετών και από άτομα με ειδικές ανάγκες ή έλλειψη εμπειρίας και γνώσης αρκεί να επιβλέπονται από άτομα υπεύθυνα για την ασφαλείά τους. Βεβαιωθείτε πως τα παιδιά δεν παίζουν με τη μονάδα.

ΑΠΟΡΡΙΨΗ: Μην απορρίπτετε αυτό το προϊόν μαζί με τα αστικά λύματα. Θα πρέπει να περισυλλέγονται για ειδική επεξεργασία.

Απαγορεύεται η απόρριψη αυτού του προϊόντος με τα αστικά λύματα. Για την απόρριψή τους υπάρχουν πολλές λύσεις:

- A) Έχουν ιδρυθεί ειδικά κέντρα απόρριψη ηλεκτρικών αποβλήτων.
- B) Κατά την αγορά ενός καινούριου προϊόντος ο προμηθευτής σας μπορεί να πάρει πίσω το παλίο χωρίς χρέωση.
- Γ) Ο κατασκευαστής μπορεί να πάρει την παλιά συσκευή χωρίς χρέωση
- Δ) Επειδή αυτά τα προϊόντα περιέχουν μεταλλικά υλικά, μπορείτε να τα πουλήσετε σε εμπόρους που αγοράζουν τέτοια υλικά.

Η απόρριψη τέτοιων προϊόντων σε δάση και πεδιάδες βάζει σε κίνδυνο την υγεία σας, καθώς τα επιβλαβή συστατικά που περιέχουν μπορεί να περάσουν στον υδριφόρο ορίζοντα και από εκεί στην τροφική αλυσίδα.





Για την αποφυγή τραυματισμού του χρήστη ή οποιουδήποτε άλλου και καταστροφή περιουσίας, πρέπει να ακολουθηθούν οι παρακάτω οδηγίες ασφαλείας. Εσφαλμένη λειτουργία εξαιτίας αγνόησης των οδηγιών μπορεί να προκαλέσει τραυματισμό.

| | | | |
|---|---|---|---|
|  | μ | μ | μ |
|  | μ | μ | μ |

■ μ μ μ

| | |
|---|--|
|  | |
|  | |







- Μην επεκτείνετε το καλώδιο και μην χρησιμοποιείτε πολύπριζα. Ελλιπής ηλεκτρολογική σύνδεση, εγκατάσταση ή αν η τάση είναι μεγαλύτερη από την επιτρεπόμενη μπορεί να προκαλέσει πυρκαγιά.
- Μην εκτείθετε το σώμα σας στον κρύο αέρα για πολλή ώρα.
- Μην εισάγετε τα δαχτυλά σας ή άλλα αντικείμενα στις εισόδους και εξόδους του αέρα.
- Μην επιχειρήσετε ποτέ να επισκευάσετε, μετακινήσετε ή να κάνετε κάποια μετατροπή στο κλιματιστικό σας. Επικοινωνήστε με τον προμηθευτή σας.
- Μην τραβάτε το καλώδιο για να το βγάλετε από την πρίζα. Κρατήστε σταθερά το καλώδιο και αφαιρέστε το φως από την πρίζα.
- Μην λειτουργείτε το κλιματιστικό σας σε υγρά μέρη όπως μπάνια.



- Εάν το κλιματιστικό χρησιμοποιηθεί μαζί με άλλες θερμαντικές συσκευές θα πρέπει να ανανεώνεται συχνά ο αέρας αλλιώς υπάρχει κίνδυνος έλλειψης οξυγόνου.
- Να αποσυνδέετε πάντα το φως από την πρίζα αν δεν χρησιμοποιήσετε τη μονάδα για αρκετό χρονικό διάστημα. Η συλλογή σκόνης μπορεί να προκαλέσει πυρκαγιά.
- Κατά τη διάρκεια καταιγίδας να απενεργοποιείτε τη μονάδα και να αποσυνδέετε το φως από την πρίζα. Μπορεί να προκληθεί φθορά στα ηλεκτρικά μέρη.
- Ελέγξτε ότι ο αγωγός αποστράγγισης είναι συνδεδεμένος σωστά. Αν όχι, μπορεί να προκληθεί διαρροή νερού.
- Ελέγξτε ότι γίνεται ελεύθερη απορροή συμπυκνωμάτων.
- Η μονάδα θα πρέπει να είναι γειωμένη σύμφωνα με τους εθνικούς κανονισμούς.
- Για λόγους ασφαλείας συνιστούμε να τοποθετήσετε ένα ρελέ διαφυγής.
- Εάν το καλώδιο τροφοδοσίας είναι φθαρμένο, πρέπει να αντικατασταθεί από τον κατασκευαστή ή από εξειδικευμένο προσωπικό.





- Μην ενεργοποιείτε διακόπτες με βρεγμένα χέρια. Μπορεί να προκληθεί ηλεκτροπληξία.
- Μην χρησιμοποιείτε τη μονάδα για άλλους σκοπούς. Μην τοποθετείτε τρόφιμα, ζώα, φυτά κλπ πάνω στη μονάδα.
- Μην εκτείθετε ζώα ή φυτά στην ροή του αέρα. Μην καθαρίζετε την κλιματιστική μονάδα με νερό.
- Μην χρησιμοποιείτε εύφλεκτα καθαριστικά διότι μπορεί να προκληθεί πυρκαγιά ή παραμόρφωση της μονάδας.
- Μην τοποθετείτε κοντά στη μονάδα αντικείμενα που βγάζουν καπνό διότι μπορεί να επηρεάσουν τον εξερχόμενο αέρα.
- Μην πατάτε πάνω στη μονάδα και μην τοποθετείτε αντικείμενα πάνω σε αυτή.
- Μην χρησιμοποιείτε ασταθή ή σκουριασμένη βάση.
- Μην τοποθετείτε τη μονάδα σε μέρος που μπορεί να εκλυθεί εύφλεκτο αέριο. Μπορεί να προκληθεί έκρηξη.
- Μην λειτουργείτε τη μονάδα για πολλή ώρα αν οι πόρτες ή τα παράθυρα είναι ανοιχτά ή αν υπάρχει υψηλή σχετική υγρασία.



- Εάν το κλιματιστικό χρησιμοποιηθεί μαζί με άλλες θερμαντικές συσκευές θα πρέπει να ανανεώνεται συχνά ο αέρας αλλιώς υπάρχει κίνδυνος έλλειψης οξυγόνου.
- Να αποσυνδέετε πάντα το φως από την πρίζα αν δεν χρησιμοποιήσετε τη μονάδα για αρκετό χρονικό διάστημα. Η συλλογή σκόνης μπορεί να προκαλέσει πυρκαγιά.
- Κατά τη διάρκεια καταιγίδας να απενεργοποιείτε τη μονάδα και να αποσυνδέετε το φως από την πρίζα. Μπορεί να προκληθεί φθορά στα ηλεκτρικά μέρη.
- Ελέγξτε ότι ο αγωγός αποστράγγισης είναι συνδεδεμένος σωστά. Αν όχι, μπορεί να προκληθεί διαρροή νερού.
- Ελέγξτε ότι γίνεται ελεύθερη απορροή συμπυκνωμάτων.
- Η μονάδα θα πρέπει να είναι γειωμένη σύμφωνα με τους εθνικούς κανονισμούς.
- Για λόγους ασφαλείας συνιστούμε α τοποθετήσετε ένα ρελέ διαφυγής.
- Εάν το καλώδιο τροφοδοσίας είναι φθαρμένο, πρέπει να αντικατασταθεί από τον κατασκευαστή ή από εξειδικευμένο προσωπικό.

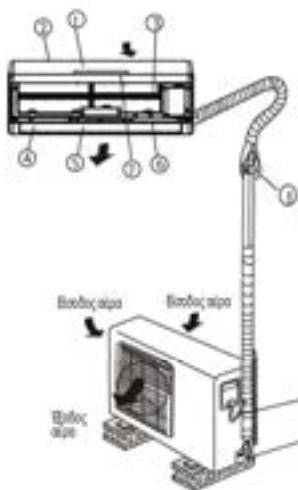

Περιγραφή Εξαρτημάτων

Εσωτερική μονάδα

1. Μπροστινό πάνελ
2. Είσοδος αέρα
3. Φίλτρο αέρα
4. Έξοδος αέρα
5. Οριζόντια περσίδα
6. Κάθετη περσίδα (μέσα)
7. Οθόνη

Εξωτερική μονάδα

8. Ψυκτικές σωληνώσεις
9. Καλώδιο σύνδεσης
10. Βαλβίδα

ΣΗΜΕΙΩΣΗ:

Όλες οι εικόνες που περιέχονται σε αυτό το εγχειρίδιο είναι μόνο για επεξηγηματικούς λόγους. Η μονάδα που έχετε προμηθευτεί μπορεί να διαφέρει στο μπροστινό πάνελ και στην οθόνη.

Ενδεικτικές λυχνίες



(Α)



(Β)

Ενδεικτικές λυχνίες

Φωτεινή Ένδειξη FRESH (προαιρετική)

Ανάβει η λυχνία όταν η λειτουργία Clean Air ενεργοποιηθεί.

Ένδειξη αποπάγωσης

(Μόνο για τα μοντέλα τύπου αντλίας θερμότητας): Ανάβει όταν η μονάδα κάνει αυτόματα αποπάγωση ή όταν κατά τη λειτουργία της θέρμανσης επιλέξετε τη λειτουργία ζεστού αέρα.



Ένδειξη θερμοκρασίας

- Όταν η μονάδα λειτουργεί εμφανίζεται η επιλεγμένη θερμοκρασία.
- Εμφανίζεται ο κωδικός σφάλματος σε περίπτωση βλάβης

Φωτεινή Ένδειξη RUN

Αυτή η λυχνία ανάβει όταν το κλιματιστικό είναι σε λειτουργία.

Ένδειξη TIMER (Χρονοδιακόπτης)

Ανάβει κατά τη λειτουργία TIMER

Ειδικές λειτουργίες

Έλεγχος διαρροής ψυκτικού υγρού

Με αυτή τη νέα τεχνολογία, όταν η εξωτερική μονάδα ανιχνεύσει διαρροή ψυκτικού υγρού, στην οθόνη θα εμφανίζεται η ένδειξη "EC" και οι ενδεικτικές λυχνίες θα αναβοσβήνουν συνεχώς.

Αποθήκευση της γωνίας ανοίγματος της περσίδας (προαιρετικά):

Στο πλαίσιο μιας γωνίας ασφαλείας, η μονάδα θα αποθηκεύσει τη γωνία ανοίγματος της οριζόντιας περσίδας.

Εάν την ξεπεράσει, θα αποθηκεύσει το όριο της γωνίας ασφαλείας. Στις παρακάτω περιπτώσεις, θα επανέλθει στην προεπιλεγμένη γωνία: 1) αν πιέσετε τον χειροκίνητο διακόπτη, 2) εάν βγάλετε και ξαναβάλτε το φιλτράκι της μονάδας στην πρίζα. Συνιστάται η γωνία ανοίγματος να μην είναι πολλή μικρή, διότι μπορεί να σχηματιστούν συμκνώματα και να στάξουν από την οριζόντια περσίδα.

Λειτουργία αυτόματου καθαρισμού (προαιρετικά)

- Αυτή η λειτουργία χρησιμοποιείται όταν απενεργοποιήσετε τη μονάδα ενώ λειτουργούσε σε κατάσταση ψύξης, για να καθαρίσει το στοιχείο για την επόμενη λειτουργία.
- Η μονάδα λειτουργεί με την παρακάτω σειρά: FAN ONLY (ΑΝΕΜΙΣΤΗΡΑΣ) στην χαμηλή ταχύτητα--Θέρμανση σε χαμηλή ταχύτητα (μόνο για τα μοντέλα τύπου αντλίας θερμότητας)--FAN ONLY--Πάυση Λειτουργίας--Απενεργοποίηση

Σημείωση:

- Αυτή η λειτουργία είναι διαθέσιμη μόνο στην ψύξη (COOL)(AUTO COOL, FORCED COOL) και κατά τη λειτουργία DRY(Αφύγραση).
- Πριν επιλέξετε τη συγκεκριμένη λειτουργία, προτείνεται να λειτουργήσετε τη μονάδα σε ψύξη για μισή ώρα περίπου. Όταν ενεργοποιηθεί η λειτουργία αυτόματου καθαρισμού, όλες οι ρυθμίσεις του TIMER θα ακυρωθούν.
- Κατά τη συγκεκριμένη λειτουργία αν πιέσετε άλλη μια φορά το πλήκτρο SELF CLEAN στο ασύρματο τηλεχειριστήριο θα σταματήσει η λειτουργία και η μονάδα θα απενεργοποιηθεί αυτόματα.

Λειτουργία καθαρισμού του αέρα (σε ορισμένα μοντέλα)

Ένας από τους σκοπούς ενός κλιματιστικού είναι και ο καθαρισμός του αέρα. Αυτή η μονάδα είναι εξοπλισμένη με ιονιστή ή Plasma Dust Collector (ανάλογα το μοντέλο). Με τα ανιόντα που παράγονται από τον ιονιστή, η κυκλοφορία του αέρα από τη μονάδα προσφέρει στον χώρο αναανεωμένο, φυσικό και υγιεινό αέρα. Το Plasma Dust Collector παράγει μια ζώνη ιονισμού υψηλής τάσης. Η σκόνη, ο καπνός από τσιγάρα και τα σωματίδια αιχμαλωτίζονται από το ηλεκτροστατικό φίλτρο.

Λειτουργία για την αποφυγή δημιουργίας μούχλας (Προαιρετικά)

- Κατά τις λειτουργίες COOL (ΨΥΞΗ), DRY (ΑΦΥΓΡΑΝΣΗ), AUTO (ΑΥΤΟΜΑΤΗ), όταν απενεργοποιήσετε τη μονάδα ο ανεμιστήρας θα συνεχίσει να λειτουργεί σε χαμηλή ταχύτητα για 7-10 λεπτά. Εάν η μονάδα λειτουργεί σε κατάσταση θέρμανσης και την απενεργοποιήσετε ο ανεμιστήρας θα συνεχίσει να λειτουργεί σε χαμηλή ταχύτητα για 30 δευτερόλεπτα. Αυτή η λειτουργία βοηθά στην απομάκρυνση της υγρασίας από το στοιχείο και έτσι αποφεύγεται η δημιουργία μούχλας.
- Κατά τη διάρκεια αυτής της λειτουργίας, μην επανεκκινήσετε την μονάδα αν προηγουμένως δεν έχει απενεργοποιηθεί.

ΣΗΜΕΙΩΣΗ: Αυτό το εγχειρίδιο δεν περιέχει οδηγίες για το ασύρματο τηλεχειριστήριο. Ανατρέξτε στο αντίστοιχο εγχειρίδιο που περιέχεται στη συσκευασία.

Θερμοκρασία λειτουργίας

| Κατάσταση λειτουργίας | Ψύξη | Θέρμανση | Αφύγρυνση |
|--------------------------------------|--|--------------------------|--------------------------|
| Θερμοκρασία χώρου | 17°C~32°C (62°F~90°F) | 0°C~30°C (32°F~86°F) | 10°C~32°C (50°F~90°F) |
| Θερμοκρασία εξωτερικού περιβάλλοντος | 0°C~50°C (32°F~122°F) (-15°C~50°C/5°F~122°F: Για τα μοντέλα με δυνατότητα ψύξης σε χαμηλές εξωτερικές θερμοκρασίες) | -15°C~30°C (5°F~86°F) | 0°C~50°C (32°F~122°F) |

ΣΗΜΕΙΩΣΗ:

1. Η βέλτιστη απόδοση επιτυγχάνεται σε αυτά τα εύρη θερμοκρασιών. Εάν το κλιματιστικό λειτουργεί εκτός των παραπάνω συνθηκών, θα ενεργοποιηθούν συγκεκριμένες προστασίες και η μονάδα δεν θα λειτουργεί σωστά.
 2. Εάν η μονάδα λειτουργεί για αρκετό χρονικό διάστημα σε ψύξη και η υγρασία είναι σε υψηλά επίπεδα (πάνω από 80%), μπορεί να εμφανιστούν συμπυκνώματα στην μονάδα. Ρυθμίστε την κάθετη περσίδα στη μέγιστη γωνία (κάθετα από το έδαφος) και ορίστε την μέγιστη ταχύτητα ανεμιστήρα.
- Πρόταση:** Για τις μονάδες με ηλεκτρική αντίσταση και όταν η εξωτερική θερμοκρασία είναι κάτω από τους 0 βαθμούς κελσίου, συνιστάται η μονάδα να παραμείνει συνδεδεμένη ώστε να εξασφαλιστεί η ομαλή της λειτουργία.

Χειροκίνητη λειτουργία

Οι μονάδες είναι εξοπλισμένες με ένα διακόπτη λειτουργίας έκτακτης ανάγκης. Είναι προσβάσιμη αν ανοίξετε το μπροστινό πάνελ. Αυτός ο διακόπτης χρησιμοποιείται για χειροκίνητη λειτουργία αν το ασύρματο τηλεχειριστήριο δεν λειτουργεί ή αν γίνονται εργασίες συντήρησης.

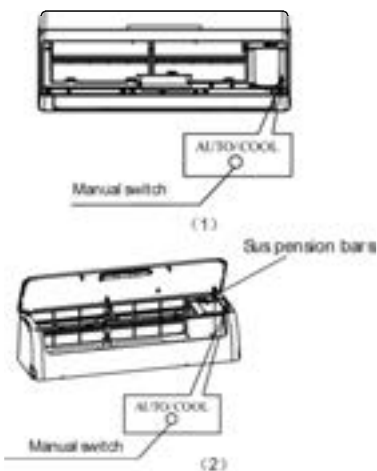

ΣΗΜΕΙΩΣΗ:

- Για να χρησιμοποιήσετε το πλήκτρο χειροκίνητης λειτουργίας θα πρέπει η μονάδα να είναι απενεργοποιημένη. Εάν η μονάδα λειτουργεί πιάστε συνεχόμενα το πλήκτρο χειροκίνητης λειτουργίας έως ότου απενεργοποιηθεί η μονάδα.
1. Σηκώστε το μπροστινό πάνελ μέχρι να ακούσετε έναν ήχο "κλικ". Για ορισμένα μοντέλα χρησιμοποιήστε τις αναρτήσεις για να στερεώσετε το πάνελ.
 2. Αν πιάσετε το πλήκτρο χειροκίνητης λειτουργίας 1 φορά η μονάδα θα λειτουργήσει σε κατάσταση AUTO(Αυτόματη). Εάν το πιάσετε 2 φορές εντός 5 δευτερολέπτων, μονάδα θα λειτουργήσει σε κατάσταση COOL (Ψύξη).
 3. Επαναφέρετε το πάνελ στην αρχική του θέση.

ΠΡΟΣΟΧΗ:

- Αυτός ο διακόπτης χρησιμοποιείται μόνο για έλεγχο λειτουργίας. Μην τον χρησιμοποιείτε.
- Για να επαναφέρετε τη λειτουργία του ασύρματου τηλεχειριστηρίου, χρησιμοποιήστε το απευθείας

Ρύθμιση της κατεύθυνσης του αέρα

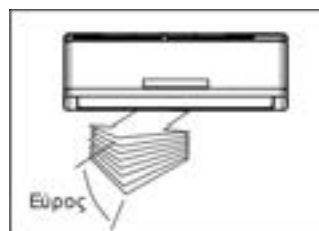

Ρυθμίστε σωστά την κατεύθυνση της ροής του αέρα αλλιώς το περιβάλλον θα είναι δυσάρεστο και δεν θα υπάρχει σωστή κατανομή της θερμοκρασίας στον χώρο. Ρυθμίστε την οριζόντια περσίδα από το ασύρματο τηλεχειριστήριο. Ρυθμίστε χειροκίνητα την κάθετη περσίδα.

Ρύθμιση της κάθετης ροής αέρα (Πάνω-Κάτω)

Αυτή η ρύθμιση πρέπει να γίνει ενώ η μονάδα λειτουργεί. Χρησιμοποιήστε το ασύρματο τηλεχειριστήριο για να ρυθμίσετε την κατεύθυνση της ροής του αέρα. Κάθε φορά που πιέζετε το πλήκτρο η οριζόντια περσίδα μετακινείται κατά 6 μοίρες ή κινείται πάνω και κάτω αυτόματα. Ανατρέξτε στο εγχειρίδιο χρήσης του ασύρματου τηλεχειριστηρίου για λεπτομέρειες.

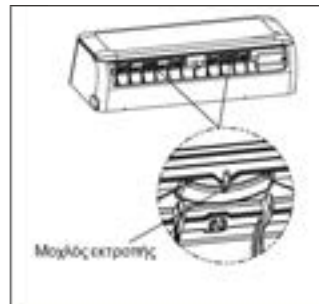

Ρύθμιση της οριζόντιας ροής του αέρα (Αριστερά-Δεξιά)

- Μετακινήστε τον μοχλό εκτροπής χειροκίνητα για να ρυθμίσετε την ροή του αέρα σύμφωνα με τις ανάγκες σας.

ΣΗΜΑΝΤΙΚΟ: Μην εισάγετε τα δάχτυλά σας στο εσωτερικό της μονάδας. Η υψηλή ταχύτητα του ανεμιστήρα μπορεί να προκαλέσει ταρματισμό.

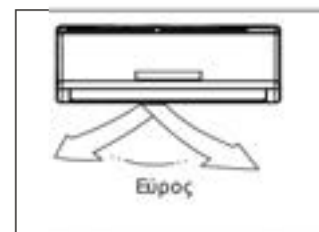

ΠΡΟΣΟΧΗ

- Όταν η μονάδα λειτουργεί σε ψύξη ή αφύγρυνση, μην επιλέγεται για αρκετό χρονικό διάστημα η κατευθυνση της ροής του αέρα να είναι προς τα κάτω. Μπορεί να δημιουργηθούν συμπυκνώματα στην οριζόντια περσίδα τα οποία θα στάζουν πάνω στο δάπεδο ή σε έπιπλα.
- Εάν απενεργοποιήσετε και ενεργοποιήσετε αμέσως τη μονάδα ή περσίδα μπορεί να μην κινηθεί για 10 δευτερόλεπτα.
- Μην επιλέγετε μικρή γωνία ανοίγματος της περσίδας, διότι μπορεί να επηρεαστεί η ψυκτική ή θερμική απόδοση της μονάδας.
- Μην κινείτε χειροκίνητα την οριζόντια περσίδα διότι θα απορυθμιστεί. Σε τέτοια περίπτωση σταματήστε τη λειτουργία, αποσυνδέστε το φις από την πρίζα για μερικά δευτερόλεπτα και έπειτα επανεκκινήστε το κλιματιστικό.
- Μην λειτουργείτε τη μονάδα με κλειστή την οριζόντια περσίδα.

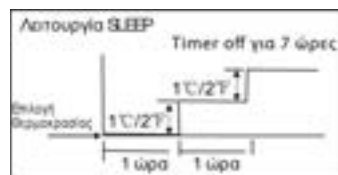
Πως λειτουργεί το κλιματιστικό

Ψύξη

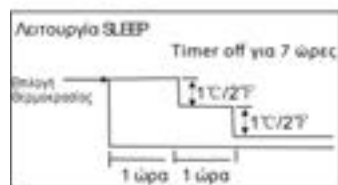

Θέρμανση

Λειτουργία AUTO (Αυτόματη)

- Όταν επιλέξετε την λειτουργία AUTO, τότε η μονάδα θα επιλέγει αυτόματα την κατάσταση λειτουργίας (ψύξη, θέρμανση ή ανεμιστήρας) ανάλογα με την επιλεγμένη θερμοκρασία και τη θερμοκρασία χώρου.
- Το κλιματιστικό θα ελέγχει τη θερμοκρασία του χώρου αυτόματα, σύμφωνα με την επιλεγμένη θερμοκρασία.
- Εάν η λειτουργία AUTO δεν είναι κατάλληλη για εσάς, μπορείτε να επιλέξετε την επιθυμητή.

Λειτουργία SLEEP

Όταν πιάσετε το πλήκτρο **SLEEP** στο ασύρματο τηλεχειριστήριο κατά τη λειτουργία ψύξης, θέρμανσης (μόνο σε μοντέλα τύπου αντλίας θερμότητας) ή AUTO (Αυτόματη), το κλιματιστικό θα αυξάνει (ψύξη) ή θα μειώνει (θέρμανση) τη θερμοκρασία κατά 1°C/ώρα για τις 2 πρώτες ώρες, έπειτα θα την κρατήσει σταθερή για 5 ώρες και μετά θα απενεργοποιηθεί. Με αυτή τη λειτουργία εξοικονομείται ενέργεια και προσφέρει άνεση κατά τη διάρκεια της νύχτας.

Λειτουργία DRY (αφύγρανση)

- Η ταχύτητα του ανεμιστήρα θα ρυθμιστεί αυτόματα σύμφωνα με τη λειτουργία της αφύγρανσης.
- Κατά τη λειτουργία της αφύγρανσης, αν η θερμοκρασία του χώρου είναι κάτω από 10°C, ο συμπιεστής σταματάει να λειτουργεί και επανεκκινείται όταν η θερμοκρασία του χώρου είναι πάνω από 12°C.

Βέλτιστη λειτουργία

- Για να επιτύχετε τη βέλτιστη λειτουργία, λάβετε υπόψη τα παρακάτω.
- Ρυθμίστε την κατεύθυνση της ροής του αέρα έτσι ώστε να μην είναι απευθείας πάνω στα άτομα που βρίσκονται στον χώρο.
- Ρυθμίστε τη θερμοκρασία ώστε να επιτύχετε το μέγιστο επίπεδο άνεσης. Μην ρυθμίζετε την θερμοκρασία σε υπερβολικά επίπεδα.
- Κατά τη λειτουργία της ψύξης ή θέρμανσης κλείστε τις πόρτες και τα παράθυρα αλλιώς μπορεί να μειωθεί η απόδοση.
- Πιάστε το πλήκτρο **TIMER ON** στο ασύρματο τηλεχειριστήριο για να επιλέξετε την ώρα που θέλετε να ενεργοποιηθεί η λειτουργία της μονάδας.
- Μην τοποθετείτε αντικείμενα κοντά στην είσοδο ή την έξοδο του αέρα, διότι μπορεί να μειωθεί η απόδοση της μονάδας ή να σταματήσει να λειτουργεί.
- Να καθαρίζετε συχνά το φίλτρο αέρα, αλλιώς μπορεί να μειωθεί ψυκτική ή θερμική απόδοση της μονάδας. Μην λειτουργείτε τη μονάδα με κλειστή την οριζόντια περσίδα.

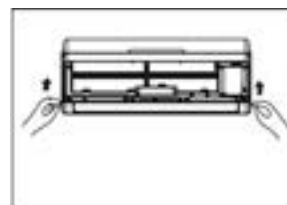
Καθαρισμός και Συντήρηση

Λαβή φίλτρου



Φίλτρο ενεργού άνθρακα

Πριν τη συντήρηση

- Απενεργοποιήστε την μονάδα πριν τον καθαρισμό και καθαρίστε τη με ένα μαλακό στεγνό πανί. Μην χρησιμοποιείτε λευκαντικά ή σπλιβωτικά
- ΣΗΜΕΙΩΣΗ:** Πριν τον καθαρισμό, θα πρέπει να έχετε απουσνδέσει την μονάδα από την παροχή ρεύματος.

ΠΡΟΣΟΧΗ

- Εάν η εσωτερική μονάδα είναι πολύ βρώμικη, μπορείτε να την καθαρίσετε με ένα βρεγμένο πανί και έπειτα να σκουπίσετε με ένα στεγνό πανί.
- Μην χρησιμοποιείτε χημικά επεξεργασμένο ξεσκονόπανο για τον καθαρισμό.
- Μην χρησιμοποιείτε βενζίνη, διαλυτικά, σπλιβωτικά ή παρόμοια διαλύματα για τον καθαρισμό. Μπορεί να προκαλέσουν παραμόρφωση ή ράγιγμα στις πλαστικές επιφάνειες της μονάδας.
- Μην χρησιμοποιείτε για τον καθαρισμό του μπροστινού πάνελ νερό πάνω από 40°C. Μπορεί να προκληθεί παραμόρφωση ή αποχρωματισμός.

Καθαρισμός της μονάδας

Χρησιμοποιήστε ένα μαλακό, στεγνό πανί. Αν η μονάδα είναι πολύ βρώμικη χρησιμοποιήστε ένα βρεγμένο πανί

Καθαρισμός του φίλτρου αέρα και του αντιμικροβιακού φίλτρου.

Ένα φραγμένο φίλτρο μειώνει την απόδοση της μονάδας.

Παρακαλούμε να καθαρίζετε τα φίλτρα κάθε 15 ημέρες.

1. Σηκώστε το μπροστινό πάνελ μέχρι να ακούσετε έναν ήχο "κλικ". Για ορισμένα μοντέλα χρησιμοποιήστε τις αναρτήσεις για να στερεώσετε το πάνελ.
 2. Τραβήξτε το φίλτρο από τη λαβή προς τα έξω και κάτω ανασκλώνοντας το ελαφρώς προς τα πάνω.
 3. Αφαιρέστε το φίλτρο από την εσωτερική μονάδα. Να καθαρίζετε το φίλτρο κάθε 15 ημέρες, είτε με ηλεκτρική σκούπα είτε με νερό και στεγνώστε το σε σκιερό μέρος.
 4. Αφαιρέστε το αντιμικροβιακό φίλτρο από τη βάση στήριξής του (σε ορισμένα μοντέλα).
- Να καθαρίζετε το αντιμικροβιακό φίλτρο τουλάχιστον 1 φορά το μήνα και να αντικαθίσταται κάθε 4-5 μήνες.
 - Να καθαρίζετε το φίλτρο είτε με ηλεκτρική σκούπα είτε με νερό και στεγνώστε το σε σκιερό μέρος



5. Τοποθετήστε το αντιμικροβιακό φίλτρο στη θέση του.
6. Εισάγετε το πάνω μέρος του φίλτρου αέρα στη μονάδα, βεβαιωθείτε πως το αριστερό και δεξί άκρο του είναι ευθυγραμμισμένο και τοποθετήστε το στη θέση του.

Αντικατάσταση του φίλτρου αέρα και του αντιμικροβιακού φίλτρου

1. Αφαιρέστε το φίλτρο αέρα.
2. Αφαιρέστε το αντιμικροβιακό φίλτρο.
3. Τοποθετήστε το νέο αντιμικροβιακό φίλτρο.
4. Επανατοποθετήστε το φίλτρο αέρα και κλείστε το μπροστινό πάνελ.



Προετοιμασία για το τέλος της περιόδου χρήσης

Όταν δεν θα χρησιμοποιήσετε τη μονάδα για αρκετό χρονικό διάστημα, να κάνετε τις παρακάτω ενέργειες:

- 1) Καθαρίστε την εσωτερική μονάδα και τα φίλτρα
- 2) Λειτουργήστε τον ανεμιστήρα για περίπου μισή ώρα ώστε να απομακρυνθεί υγρασία από το εσωτερικό της μονάδας.
- 3) Απενεργοποιήστε τη λειτουργία της μονάδας και αποσυνδέστε την παροχή ρεύματος.
- 4) Αφαιρέστε τις μπαταρίες από το ασύρματο τηλεχειριστήριο. Η εξωτερική μονάδα χρειάζεται περιοδική συντήρηση και καθαρισμό. Μην κάνετε αυτές τις εργασίες μόνοι σας. Επικοινωνήστε με τον προμηθευτή σας.

Έλεγχοι πριν την έναρξη περιόδου χρήσης

- Ελέγξτε ότι τα καλώδια δεν είναι φθαρμένα και πως δεν είναι αποσυνδεδεμένα.
- Καθαρίστε την εσωτερική μονάδα και τα φίλτρα.
- Βεβαιωθείτε πως το φίλτρο είναι τοποθετημένο.
- Βεβαιωθείτε πως δεν παρεμποδίζεται η έσοδος και η έξοδος του αέρα, εφόσον η μονάδα δεν έχει λειτουργήσει για αρκετό χρονικό διάστημα.

⚠ Προσοχή

- Όταν αφαιρείτε τα φίλτρα μην ακουμπάτε τα μεταλλικά μέρη της μονάδας, υπάρχει κίνδυνος τραυματισμού. Μην καθαρίζετε το εσωτερικό της μονάδας με νερό.
- Μπορεί να καταστραφεί η μόνωση και να προκληθεί ηλεκτροπληξία.
- Κατά τον καθαρισμό της μονάδας βεβαιωθείτε πως η μονάδα δεν είναι συνδεδεμένη με την παροχή ρεύματος και ο διακόπτης είναι σε θέση off.
- Μην πλένετε τα φίλτρα με νερό πάνω από 40°C. Στεγνώστε το σε σκιερό μέρος και μην το εκτείθετε απευθείας στην ηλιακή ακτινοβολία. Μπορεί να συρρικνωθεί.

Κανονική λειτουργία της κλιματιστικής μονάδας

Τα παρακάτω φαινόμενα μπορεί να εμφανιστούν κατά την ομαλή λειτουργία.

1. Προστασία του κλιματιστικού.

Προστασία συμπίεστή

- Όταν ο συμπίεστής δεν μπορεί να επανεκκινήσει για 3-4 λεπτά σταματάει να λειτουργεί.
- Η μονάδα είναι σχεδιασμένη κατά τη λειτουργία της θέρμανσης να μην εξέρχεται κρύος αέρας, όταν ο εναλλάκτης της εσωτερικής μονάδας βρίσκεται σε κάποια από τις παρακάτω καταστάσεις.

- A) Όταν έχει μόλις επιλεγεί η λειτουργία της θέρμανσης.
- B) Αποπάγωση
- Γ) Θέρμανση σε χαμηλή εξωτερική θερμοκρασία

- Ο ανεμιστήρας της εσωτερικής και εξωτερικής μονάδας σταματούν κατά την αποπάγωση (Μόνο για μοντέλα τύπου αντλίας θερμότητας)

Αποπάγωση (Μόνο για μοντέλα τύπου αντλίας θερμότητας)

- Κατά τη λειτουργία της θέρμανσης μπορεί να δημιουργηθεί πάγος στην εξωτερική μονάδα αν η εξωτερική θερμοκρασία είναι πολλή χαμηλή και η σχετική υγρασία υψηλή, με αποτέλεσμα την μείωση της απόδοσης της μονάδας.
- Σε αυτή την περίπτωση σταματάει η λειτουργία της μονάδας και ενεργοποιείται αυτόματα η αποπάγωση.
- Ο χρόνος αποπάγωσης κυμαίνεται από 4 έως 10 λεπτά ανάλογα την εξωτερική θερμοκρασία και τον όγκο του πάγου που έχει σχηματιστεί στην εξωτερική μονάδα.

2. Μια λευκή ομίχλη εξέρχεται από την εσωτερική μονάδα

- Λευκή ομίχλη μπορεί να εμφανιστεί κατά τη λειτουργία της ψύξης, λόγω μεγάλης διαφοράς θερμοκρασίας ανάμεσα στην είσοδο και έξοδο του αέρα όταν στον χώρο υπάρχει υψηλή σχετική υγρασία.
- Λευκή ομίχλη μπορεί να εμφανιστεί λόγω της υγρασίας που παράγεται κατά τη διαδικασία της αποπάγωσης, όταν η μονάδα επανέρχεται στη λειτουργία της θέρμανσης.

3. Ακούγεται ένας χαμηλός θόρυβος από το κλιματιστικό

- Μπορεί να ακούσετε ένα χαμηλό συνεχόμενο θόρυβο κατά τη λειτουργία του συμπίεστή ή όταν έχει μόλις σταματήσει. Είναι ο ήχος του ψυκτικού υγρού που ρέει ή όταν σταματάει τη ροή.
- Μπορεί επίσης να ακούσετε ένα τριξίμο κατά τη λειτουργία του συμπίεστή ή όταν έχει μόλις σταματήσει. Προκαλείται από τις διαστολές και συστολές των πλαστικών μερών της μονάδας λόγω των μεταβολών της θερμοκρασίας.
- Μπορεί να ακουστεί κάποιος θόρυβος από την περσίδα όταν αυτή επανέρχεται στην αρχική της θέση κατά την ενεργοποίηση της μονάδας.

4. Εξέρχεται σκόνη από την εσωτερική μονάδα

Είναι φυσιολογικό να εμφανίζεται όταν η μονάδα δεν έχει λειτουργήσει για αρκετό χρονικό διάστημα ή όταν λειτουργεί για πρώτη φορά.

5. Αναδύεται μια ιδιαίτερη μυρωδιά από την εσωτερική μονάδα

Οφείλεται στην διείσδυση οσμών στην εσωτερική μονάδα από τα υλικά του κτιρίου, τα έπιπλα ή καπνό από τσιγάρα.

6. Η μονάδα αλλάζει κατάσταση από ψύξη ή θέρμανση σε ανεμιστήρα.

Όταν η θερμοκρασία του χώρου φτάσει την επιλεγμένη, ο συμπίεστής σταματάει αυτόματα και το κλιματιστικό λειτουργεί σε κατάσταση FAN(ανεμιστήρας). Όταν η θερμοκρασία του χώρου αυξηθεί όταν η μονάδα βρίσκεται σε λειτουργία ψύξης ή μειωθεί σε λειτουργία θέρμανσης, τότε ο συμπίεστής θα αρχίσει πάλι να λειτουργεί.

7. Όταν απενεργοποιείτε το κλιματιστικό ενεργοποιείται η λειτουργία για την αποφυγή δημιουργίας μούχλας.

Όταν απενεργοποιείτε τη μονάδα ενώ λειτουργεί σε κατάσταση ψύξης ή αφύγρανσης, για 7-10 λεπτά θα ενεργοποιηθεί η λειτουργία για την αποφυγή δημιουργίας μούχλας. Εάν απενεργοποιήσετε τη μονάδα ενώ λειτουργεί σε κατάσταση θέρμανσης, θα συνεχίσει να λειτουργεί σε χαμηλή ταχύτητα για 30 δευτερόλεπτα, έπειτα θα σταματήσει και τέλος θα απενεργοποιηθεί αυτόματα.

8. Όταν η μονάδα λειτουργεί σε ψύξη ενώ η σχετική υγρασία είναι υψηλή (πάνω από 80%) μπορεί να εμφανιστούν συμπυκνώματα πάνω στην επιφάνεια της εσωτερικής μονάδας. Ρυθμίστε την οριζόντια περσίδα στην μέγιστη γωνία και επιλέξτε τη μεγάλη ταχύτητα ανεμιστήρα.

9. Λειτουργία θέρμανσης (μόνο για μοντέλα τύπου αντλίας θερμότητας)

Το κλιματιστικό απορροφά θερμότητα από το εξωτερικό περιβάλλον μέσω της εξωτερικής μονάδας και την εκλύει στον χώρο μέσω της εσωτερικής μονάδας. Όταν μειώνεται η εξωτερική θερμοκρασία, μειώνεται αντίστοιχα και η θερμότητα που απορροφάται από το κλιματιστικό. Ταυτόχρονα αυξάνεται το θερμικό φορτίο του κλιματιστικού λόγω της μεγαλύτερης διαφοράς μεταξύ εσωτερικής και εξωτερικής θερμοκρασίας. Εάν με το κλιματιστικό δεν μπορεί να επιτευχθεί επιθυμητή θερμοκρασία, συνιστούμε να χρησιμοποιήσετε βοηθητικά μια θερμαντική συσκευή.

10. Λειτουργία αυτόματης επανεκκίνησης

- Μια διακοπή ρεύματος κατά τη λειτουργία θα σταματήσει τελείως τη μονάδα.
- Στις μονάδες χωρίς αυτόματη επανεκκίνηση, όταν επανέλθει το ρεύμα η ενδεικτική λυχνία λειτουργίας θα αρχίσει να αναβοσβήνει. Για να επανεκκινήσετε τη μονάδα πιέστε το πλήκτρο ON/OFF στο ασύρματο τηλεχειριστήριο. Στις μονάδες με αυτόματη επανεκκίνηση, όταν επανέλθει το ρεύμα η μονάδα επανεκκινείται αυτόματα έχοντας αποθηκευμένες όλες τις ρυθμίσεις που είχαν γίνει.

Οδηγός αντιμετώπισης προβλημάτων

| | |
|---|---|
| Εάν συμβεί κάποιο από τα παρακάτω σφάλματα, σταματήστε τη λειτουργία του κλιματιστικού αμέσως, αποσυνδέστε το από το ρεύμα και ξανά συνδέστε το. Αν το πρόβλημα συνεχίσει να υπάρχει, αποσυνδέστε από το ρεύμα και επικοινωνήστε με το κοντινότερο κέντρο σέρβις. | |
| Πρόβλημα | Αναβοσβήνει η ένδειξη OPERATION ή άλλες ενδείξεις. |
| | Καίγεται συχνά η ασφάλεια ή πέφτει συνεχώς ο ασφαλειοδιακόπτης. |
| | Άλλα στοιχεία ή νερό έχουν πέσει πάνω στο κλιματιστικό. |
| | Το τηλεχειριστήριο δεν δουλεύει ή παρουσιάζει ανώμαλη λειτουργία. |
| Εάν ένας από τους παρακάτω κωδικούς εμφανιστεί στην οθόνη: E0, E1, E2, E3.....ή P0, P1, P2, P3..... | |

| Δυσλειτουργίες | Αιτία | Τι πρέπει να κάνετε |
|--|---|--|
| Η μονάδα δεν ξεκινάει | Διακοπή ρεύματος | Περιμένετε για την επανασύνδεση του ρεύματος. |
| | Μπορεί να έχει βγει το καλώδιο τροφοδοσίας από την πρίζα. | Ελέγξτε ότι το φις είναι στην πρίζα και ότι η πρίζα είναι σταθερή στον τοίχο. |
| | Μπορεί να έχει καεί ασφάλεια. | Αντικαταστήστε την ασφάλεια. |
| | Μπορεί να έχουν εξαντληθεί οι μπαταρίες του ασύρματου τηλεχειριστηρίου. | Αντικαταστήστε τις μπαταρίες. |
| | Η ώρα που έχετε ορίσει στο timer είναι λάθος. | Περιμένετε ή ακυρώστε την ρύθμιση του timer. |
| Ενώ υπάρχει ροή αέρα στον χώρο από το κλιματιστικό, δεν γίνεται επαρκής ψύξη ή θέρμανση (μόνο για τα μοντέλα τύπου αντλίας θερμότητας) | Ακατάλληλη ρύθμιση θερμοκρασίας | Ρυθμίστε σωστά τη θερμοκρασία. Για λεπτομέρειες ανατρέξτε στο εδάφιο "Λειτουργίες ασύρματου τηλεχειριστηρίου". |
| | Το φίλτρο αέρα είναι φραγμένο. | Καθαρίστε το φίλτρο |
| | Υπάρχουν πόρτες και παράθυρα ανοιχτά. | Κλείστε τις πόρτες ή τα παράθυρα. |
| | Παρεμποδίζεται η είσοδος ή η έξοδος του αέρα. | Απομακρύνετε τα εμπόδια και επανεκκινήστε τη μονάδα. |
| | Έχει ενεργοποιηθεί η προστασία 3 λεπτών του συμπιεστή. | Περιμένετε. |
| Εάν το σφάλμα παραμένει, παρακαλούμε επικοινωνήστε με τον προμηθευτή σας και ενημερώστε τους για το ακριβές μοντέλο και λεπτομερώς για τη βλάβη. | | |

Σημειώσεις: Μην επιχειρήσετε να επιδιορθώσετε το κλιματιστικό μόνοι σας. Να συμβουλευέστε πάντα τον προμηθευτή σας.

Ενεργοποιήστε την εγγύηση σας...

σε **5**
απλά
βήματα!



Σκανάρετε εδώ
για τα έντυπα
των εγγυήσεων

- 1** Συνδεθείτε στο site της **Inventor** στον ακόλουθο σύνδεσμο <http://www.inventoraircondition.gr/egiisi-inventor/>
- 2** Επιλέξτε τον τύπο του προϊόντος (κλιματιστικό ή συσκευή) για το οποίο θα ενεργοποιηθεί η εγγύηση
- 3** Επιλέξτε την εγγύηση που αντιστοιχεί στο προϊόν που έχετε στην κατοχή σας
- 4** Συμπληρώστε τα απαιτούμενα στοιχεία (κατόχου, εμπόρου και συσκευής) και πατήστε αποστολή
- 5** Θα λάβετε επιβεβαιωτικό μήνυμα στο e-mail σας για την ενεργοποίηση της εγγύησης

Για την υποβολή
ηλεκτρονικών εγγυήσεων
ηλεκτρολογήστε
την παρακάτω διεύθυνση

<http://www.inventoraircondition.gr/egiisi-inventor/>

CUPRINS

MĂSURI DE SIGURANȚĂ

| | |
|-------------------|---|
| Atenționare | 3 |
| Atenție | 4 |

DENUMIREA COMPONENTELOR

| | |
|-----------------------|---|
| Unitate internă | 5 |
| Unitate externă | 5 |
| Led indicator | 5 |

INSTRUCȚIUNI DE FOLOSIRE

| | |
|--|---|
| Funcții speciale | 6 |
| Temperaturi de funcționare | 7 |
| Funcționare manuală | 7 |
| Controlarea fluxului de aer | 8 |
| Cum funcționează aparatul de aer condiționat | 9 |

ÎNTREȚINERE

| | |
|---|----|
| Înainte de întreținere | 10 |
| Curățarea echipamentului | 10 |
| Curățarea filtrului de aer și a filtrului de îmborsărire a aerului | 10 |
| Înlocuirea filtrului de aer și a filtrului de îmborsărire a aerului | 11 |
| Pregătirea pentru perioade extinse de nefuncționare | 11 |
| Verificarea de dinainte de sezon | 11 |

SFATURI DE DEPANARE

| | |
|--|----|
| Funcționarea normală a echipamentului de aer condiționat | 12 |
| Ghid de depanare | 14 |

La utilizarea acestui aparat de aer condiționat, în țările europene, vă rugăm să citiți următoarele informații:

- Acest aparat poate fi folosit de copii cu vârstă mai mare de 8 ani și peste și persoane cu capacități fizice, senzoriale sau mentale reduse, sau lipsite de experiență și cunoștințe în cazul în care acestea au fost supravegheate și instruite cu privire la utilizarea aparatului într-un mod sigur și de a înțelege pericolele implicate. Copiii nu trebuie să se joace cu aparatul de aer condiționat. Curățarea și întreținerea echipamentului nu se face de către copii fără supraveghere

RECICLAREA ECHIPAMENTULUI: Nu aruncați acest produs împreună cu gunoiul menajer. Este necesară colectarea acestor deșeuri separat pentru tratament special



Se interzice aruncarea acestui echipament în deșeurile menajere domestice. Pentru aceasta, există mai multe posibilități:

- A) Municipality a stabilit locuri de colectare, în care deșeurile electronice pot fi colectate gratuit pentru utilizatorul echipamentului.
- B) Atunci când cumpărați un produs nou, vânzătorul va lua înapoi produsul vechi în mod gratuit
- C) Producătorul va lua înapoi aparatul vechi pentru reciclarea acestuia în mod gratuit pentru utilizator
- D) Ca și produsele vechi și acestea conțin resurse valoroase, și pot fi vândute ca resturi la comercianții de metal

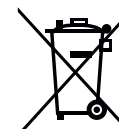

Aruncarea deșeurilor în păduri și pe diverse terenuri pune în pericol sănătatea dumneavoastră, atunci când substanțele periculoase se scurg în apă-sol și își găsesc astfel drum în lanțul alimentar



Pentru a preveni vătămarea corporală a utilizatorului sau a altor persoane și pagube materiale, trebuie respectate următoarele instrucțiuni. Funcționarea incorectă din cauza ignorării instrucțiunilor poate cauza prejudicii sau daune

| | |
|---|---|
|  AVERTIZARE | Acest simbol indică posibilitatea de deces sau vătămare gravă |
|  ATENȚIE | Acest simbol indică posibilitatea de rănire sau daune materiale |

■ Semnificațiile simbolurilor utilizate în acest manual sunt prezentate mai jos

| | |
|---|---------------------------------------|
|  | Strict interzis |
|  | Asigurați-vă că urmați instrucțiunile |

 **AVERTIZARE**



- Nu prelungiți cablul și nu utilizați mai multe prize. O conexiune electrică slabă, o izolare necorespunzătoare sau o tensiune mai mare decât cea permisă poate provoca un incendiu
- Nu vă expuneți corpul direct la fluxul de aer rece pentru o perioadă îndelungată. Nu introduceți degetele, bețe sau alte obiecte în orificiile de admisie și evacuare a aerului
- Nu încercați niciodată să reparați, mutați sau să modificați echipamentul de aer condiționat. Întotdeauna contactați partenerul dumneavoastră de service, dacă este nevoie
- Nu scoateți ștecherul din priză trăgând de cablu. Țineți ferm priza și trageți-l afară din priză ținând de ștecher, altfel există riscul de deteriorare a cablului
- Nu folosiți aparatul de aer condiționat într-o cameră cu umezeală ridicată, cum ar fi o baie sau spălătorie.
- Îndepărtați toată murdăria de pe cablul de alimentare și conectați-l cu fermitate. Prizele murdare pot provoca un incendiu sau un șoc electric



- În caz de anomalii în funcționare, cum ar fi mirosul de ars, opriți imediat aparatul și scoateți-l din priză. Contactați partenerul de service
- Întotdeauna opriți aparatul și scoateți ștecherul din priză înainte de a începe să-l curățați.
- Utilizați cablul de alimentare specificat.
- Contactați instalatorul autorizat pentru instalarea acestui aparat
- Contactați un tehnician de service autorizat pentru reparația sau întreținerea acestui aparat
- Acest aparat nu este destinat utilizării de către persoane (inclusiv copii) cu capacități fizice reduse, senzoriale sau mentale, sau lipsite de experiență și cunoștințe, cu excepția cazului în care acestea au fost supravegheate și instruite cu privire la utilizarea aparatului de către o persoană responsabilă pentru siguranța lor
- Copiii trebuie supravegheați pentru a ne asigura că nu se joacă cu aparatul de aer condiționat

 **ATENȚIE**



- Nu acționați niciodată orice întrerupătoare cu mâinile ude. Acest lucru poate provoca un șoc electric.
- Nu utilizați niciodată aparatul în alt scop decât cel pentru care a fost fabricat. Nu puneți niciodată alimente, instrumente de precizie, plante, animale, vopsea, etc pe echipamentul de aer condiționat
- Nu expuneți plantele sau animalele direct fluxului de aer
- Nu curățați niciodată aparatul de aer condiționat cu apă. Nu utilizați niciodată agenți de curățare combustibili, deoarece ar putea provoca un incendiu sau deformare.
- Nu așezați obiecte care ard aproape de aparat, dacă acestea ar putea fi afectate în mod direct de aerul emis de aparat
- Nu călcați pe unitatea externă și nu așezați nimic pe ea
- Nu folosiți niciodată o bază instabilă sau ruginită. Nu instalați aparatul de aer condiționat în locuri în care pot fi emise gaze sau lângă combustibil. Gazele emise se pot acumula și provoca o explozie.
- Nu lăsați niciodată aparatul de aer condiționat să funcționeze pentru prea mult timp, cu ușile și ferestrele deschise, sau în cazul în care umiditatea este foarte mare.



- În cazul în care aparatul de aer condiționat este utilizat în combinație cu alte încălzitoare, aerul ar trebui împropătat periodic, în caz contrar există riscul de lipsă de oxigen
- Decuplați întotdeauna cablul de alimentare de la priză în cazul în care unitatea nu va fi folosită pentru o perioadă lungă de timp.
- Acumularea de praf poate provoca incendii.
- Întotdeauna opriți aparatul de aer condiționat și scoateți ștecherul din priză în timpul unei furtuni. Piesele electrice pot fi deteriorate.
- Verificați dacă furtunul de dren este conectat corect. Dacă nu, apa se va elimina prin unitatea interioară.
- Verificați dacă apa acumulată se poate elimina fără probleme. Aceasta apă poate provoca daune în cazul în care tava de condensare nu este instalată în mod corespunzător
- Aparatul de aer condiționat trebuie să fie împământat în conformitate cu codurile locale.
- Din motive de siguranță electrică, vă recomandăm să instalați o siguranță pentru împământare.
- În cazul în care cablul de alimentare este deteriorat, acesta trebuie înlocuit de către producător, agentul de service sau persoane calificate, în scopul de a evita un pericol

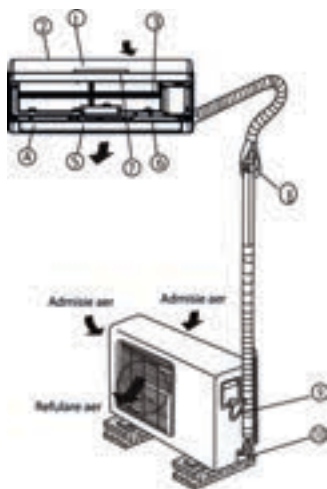

Denumirea Componentelor

Unitatea Internă

1. Panel frontal
2. Admisie aer
3. Filtru de aer
4. Refulare aer
5. Flapsuri orizontale de ghidare a aerului
6. Flapsuri de ghidare a aerului (interioare)
7. Panou afișaj

Unitatea Externă

1. Țeava de conectare
2. Cablu de conectare
3. Valva de oprire

NOTĂ:

Toate imaginile din acest manual sunt doar pentru scopuri de prezentare. Forma actuală a unității interioare pe care ați achiziționat-o poate fi ușor diferită la panelul frontal și panoul de afișaj. Forma actuală are prioritate.

Led Indicator



(A)

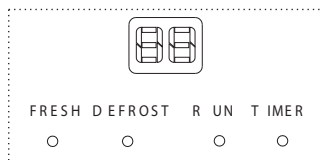

(B)

Ledul indicator

Lampă indicator FRESH (opțional): Se aprinde când funcția de Aer Curat este activată

Ledul indicator pentru DEGIVRARE (Disponibil numai pentru modelele cu funcție de Răcire & Încălzire)

Se aprinde automat când începe degivrarea aparatului de aer condiționat sau în cazul în care funcția de control de aer cald este setată



Ledul indicator pentru TEMPERATURĂ

- Afișează setările de temperatură, atunci când aparatul de aer condiționat este în funcțiune.
- Afișează codul de eroare atunci când se produce o defecțiune.

Lampă indicator FUNCȚIONARE:

Se aprinde când aparatul de aer condiționat este în funcțiune.

Ledul indicator pentru PROGRAMARE

Acest led este aprins în timpul cât aparatul este programat să funcționeze.

Funcții speciale

Detectarea scurgerilor de freon

Cu aceasta nouă tehnologie, pe afișajul unității va apărea CE și ledurile de semnalizare continuă să pâlpâie intermitent atunci când unitatea exterioară detectează scurgeri de agent frigorific

Funcția de memorare a poziției flapsurilor (opțional)

Cu scopul de aplicare al unghiului de siguranță, se va memora unghiul de deschidere al flapsurilor orizontale. Dacă acesta se depășește, se va memora limita unghiului de siguranță. În următoarele situații, se va reveni la unghiul standard: 1) apăsând butonul manual, 2), deconectați și apoi reconectați echipamentul la priză. Deci, vă sugerăm ca unghiul deschis al flapsurilor orizontale să nu fie prea mic, în cazul în care picăturile de apă condensate cad de pe flapsurile orizontale.

Funcția de AUTOCURĂȚARE

- Această funcție este utilizată când echipamentul este oprit și după ce aparatul a funcționat în modul de răcire pentru curățarea vaporizatorului și păstrându-l astfel la fel de curat și pentru următoarea funcționare a aparatului.
- Unitatea va funcționa cu următoarea succesiune: Mod VENTILARE la viteză redusă a ventilatorului – În încălzire cu viteză redusă a ventilatorului (aplicabil numai pentru modelele cu răcire & încălzire) -- funcționare NUMAI în modul VENTILARE – Oprește funcționare – Oprește completă
- Notă: Această funcție este disponibilă doar în modul RĂCIRE (AUTO RĂCIRE, RĂCIRE forțată) și modul de DEZUMIDIFICARE. Înainte să selectați funcția, este recomandată funcționarea aparatului în modul de răcire pentru o jumătate de oră. Odată ce funcția Auto Curățare este activată, toate setările și programările vor fi anulate. În timpul funcționării în modul Auto Curățare, atunci când apăsați această tastă de pe telecomandă din nou se va opri funcționarea în acest mod și de asemenea se va opri și aparatul automat

Funcția de Curățare a aerului (disponibilă la anumite modele)

Îmbunătățirea calității aerului din cameră este unul dintre scopurile unui aparat de aer condiționat. Acest aparat de aer condiționat este dotat cu ionizator sau colector de praf cu plasmă (În funcție de configurația specifică modelului). Cu anionii generați de ionizator, aparatul de aer condiționat umple camera cu un aer răcoritor, natural și sănătos. Colectorul de praf cu plasmă generează o zonă de ionizare de înaltă tensiune, prin care aerul este transformat în plasmă. În interiorul aparatului majoritatea particulelor de praf, fum și polen sunt capturate de către filtrul electrostatic.

Funcția Anti- Mucegai

- La oprirea aparatului din modul RĂCIRE, DEZUMIDIFICARE, AUTO (RĂCIRE), aparatul de aer condiționat va continua să funcționeze timp de aproximativ 7-10 minute (în funcție de model) la viteza MICĂ a ventilatorului. În cazul în care aparatul se oprește din modul ÎNCĂLZIRE, unitatea va continua să funcționeze pentru aproximativ 30 de secunde la viteza MICĂ a ventilatorului. Acest lucru va ajuta să se usuce apa condensată în interiorul evaporatorului, și pentru a preveni dezvoltarea de mucegai.
- În modul de funcționare anti-mucegai, nu reporniți aparatul de aer condiționat până când unitatea este complet oprită.

NOTĂ: Acest manual nu include funcțiile telecomenzii, pentru detalii a se vedea << instrucțiuni de folosire a telecomenzii >> ambalate cu echipamentul de aer condiționat.

Temperaturi de funcționare

| Mod | Funcționare în Răcire | Funcționare în Încălzire | Funcționare în Dezumidificare |
|------------------------|---|--------------------------|-------------------------------|
| Temperatură interioară | 17°C~32°C (62°F~90°F) | 0°C~30°C (32°F~86°F) | 10°C~32°C (50°F~90°F) |
| Temperatură exterioară | 0°C~50°C (32°F~122°F) | -15°C~30°C (5°F~86°F) | 0°C~50°C (32°F~122°F) |
| | (-15°C~50°C/5°F~122°F: Pentru modele cu sistem de răcire la temperaturi joase) | | |

NOTĂ:

1. Performanța optimă va fi atinsă în aceste temperaturi de funcționare. În cazul în care aparatul de aer condiționat este utilizat în afara condițiilor de mai sus, anumite caracteristici de protecție și siguranță s-ar putea activa și cauza unitatea să funcționeze anormal.

2. În cazul în care aparatul de aer condiționat funcționează pentru o lungă perioadă de timp în modul de răcire, iar umiditatea este ridicată (peste 80%), apa condensată se poate scurge din unitate. Vă rugăm setați flapsurile în poziție verticală la unghiul maxim (vertical pe podea), și ventilatorul pe viteză MARE

SUGESTIE: Pentru aparatul la care se montează un încălzitor electric auxiliar, atunci când temperatura mediului ambiant exterior este sub 0 °C (32 °F), vă recomandăm să vă păstrați aparatul conectat, în scopul de a garanta o funcționare fără probleme.

Funcționare manuală

Unitățile sunt echipate cu un comutator pentru a opera în modul de funcționare de urgență. Acesta poate fi accesat prin deschiderea panoului frontal. Acest comutator este utilizat pentru operarea manuală, în cazul în care telecomanda nu funcționează sau este necesară o servizare a echipamentului

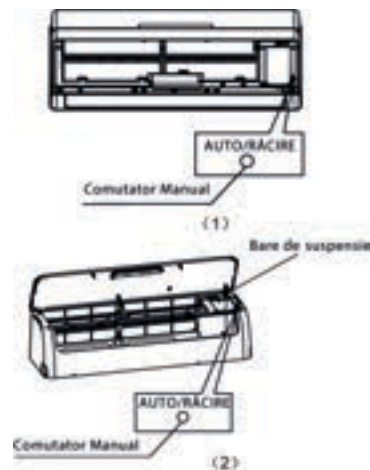

NOTĂ:

Unitatea trebuie să fie oprită înainte de a utiliza butonul de control manual. În cazul în care unitatea este în funcțiune, continuați să apăsați butonul de control manual, până când aparatul se oprește

- ① Deschideți și ridicați panoul frontal până la un unghi în care rămâne fix cu un sunet de clic. Pentru unele modele, vă rugăm să folosiți barele de suspendare pentru a sprijini panoul frontal
- ② O singură apăsare a comutatorului de control manual va conduce la funcționarea AUTO forțată. Dacă apăsați butonul de două ori în cinci secunde, aparatul va funcționa în modul RĂCIRE forțată
- ③ Închideți ferm panelul frontal în poziția sa inițială

ATENȚIE:

- Acest comutator este utilizat numai în scop de testare. Este de preferat să nu îl utilizați.
- Pentru a restabili funcționarea din telecomandă, folosiți telecomanda direct.

Controlul fluxului de aer

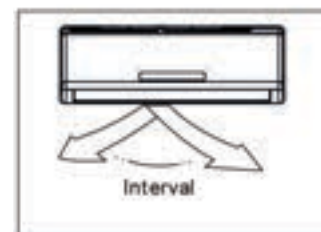
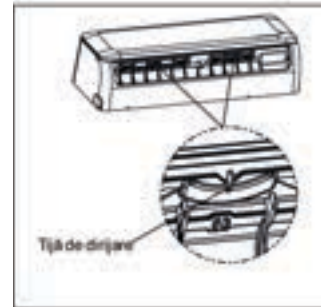
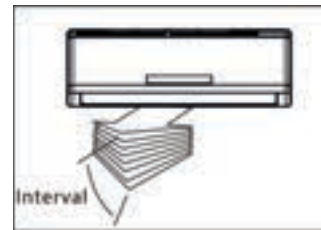

Reglează direcția fluxului de aer în mod corespunzător în caz contrar s-ar putea cauza un disconfort sau se determină apariția temperaturilor inegale în camere

Reglați flapsurile orizontale utilizând telecomanda
Reglați manual flapsurile verticale

Pentru a seta direcția fluxului de aer (Sus-Jos)

Efectuați această operațiune în timp ce aparatul este în funcțiune. Utilizați telecomanda pentru a regla direcția fluxului de aer. Flapsul orizontal poate fi mutat la un unghi de 6 grade pentru fiecare apăsare, sau dirijați în sus și în jos în mod automat. Vă rugăm să consultați manualul de funcționare al telecomenzii pentru detalii

Pentru a seta direcția fluxului de aer (Stânga-Dreapta)

Mutați manual tija de dirijare a aerului, pentru a regla fluxul de aer în direcția pe care o preferați

IMPORTANT:

- Nu introduceți degetele în fanta de suflare a aerului și nici în partea de aspirație. Ventilatorul de mare viteză din interiorul unității interne poate provoca rănirea dvs

⚠ ATENȚIE:

- Nu folosiți aparatul de aer condiționat pentru perioade lungi de timp, cu direcția fluxului de aer stabilit în jos în modul de răcire sau dezumidificare. În caz contrar, se poate forma condens pe suprafața flapsurilor orizontale ce duce ca apa rezultată din condens să cadă pe podea sau pe mobilier
- Când aparatul de aer condiționat este pornit imediat după ce a fost oprit, flapsul orizontal s-ar putea să nu se deplaseze pentru aproximativ 10 secunde
- Unghiul de deschidere al flapsurilor orizontale nu trebuie să fie prea mic, deoarece funcția de răcire sau încălzire poate fi afectată din cauza că zona de eliberare a fluxului de aer este prea limitată
- Nu mișcați manual flapsurile orizontale altfel flapsurile nu vor mai fi sincronizate. În caz contrar vă rugăm să opriți echipamentul, să îl deconectați de la priză pentru câteva secunde, iar apoi reporniți aparatul de aer condiționat
- Nu utilizați echipamentul cu flapsurile orizontale în poziția închisă

Cum Funcționează Echipamentul De Aer Condiționat

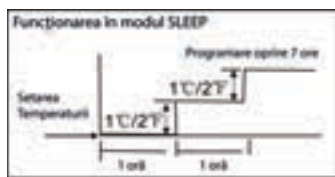

Răcire

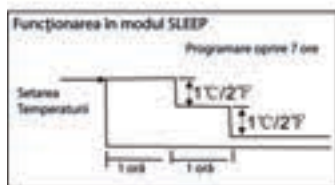

Încălzire

Funcționarea AUTO

- Când setați aparatul de aer condiționat în modul AUTO, se va selecta în mod automat funcția de răcire, încălzire (numai pentru modele cu funcție de răcire / încălzire), sau doar ventilare în funcție de temperatura setată și temperatura camerei.
- Aparatul de aer condiționat va controla temperatura camerei, în mod automat la punctul de temperatură setat.
- Dacă vă simțiți inconfortabil în modul AUTO, puteți seta temperatura dorită.

Funcționarea în modul SLEEP

Atunci când apăsați tasta SLEEP de pe telecomandă în timpul funcționării în răcire, încălzire (numai pentru modelele cu funcție de răcire și de încălzire), sau în modul AUTO, instalația de aer condiționat va crește temperatura cu 1 °C, în mod automat (în modul răcire) sau scadea (în modul încălzire) pe oră pentru primele 2 ore, apoi o păstrează în mod constant pentru următoarele 5 ore, după care se va opri. Acest mod economisește energie și va aduce confort pe timp de noapte.

Funcția de DEZUMIDIFICARE

- Viteza ventilatorului va fi controlată automat în modul de dezumidificare
- În timpul operațiunii de dezumidificare, în cazul în care temperatura camerei este mai mică decât 10°C (50°F), compresorul se oprește și repornește când temperatura camerei este peste 12°C (50°F).

Funcționarea optimă

- Pentru a obține performanțe optime, vă rugăm să rețineți următoarele aspecte:
- Ajustați direcția fluxului de aer în mod corect, astfel încât să nu fie îndreptat către oameni
- Setați temperatura astfel încât să atingeți cel mai înalt nivel de confort. Nu reglați aparatul la niveluri excesive de temperatură.
- Închideți ușile și ferestrele în timpul funcționării aparatului în modurile de răcire sau încălzire, altfel se reduce performanța echipamentului.
- Utilizați tasta TIMER ON de pe telecomandă pentru a selecta timpul de pornire al aparatului dvs. de aer condiționat.
- Nu puneți nici un obiect în apropierea fantei de admisie sau de evacuare a aerului, deoarece eficiența aparatului de aer condiționat poate fi redusă și echipamentul se poate opri
- Curățați periodic filtrul de aer, altfel performanța echipamentului în modul de răcire sau de încălzire poate fi redusă. Nu utilizați echipamentul cu flapsurile orizontale în poziție închisă

Întreținere

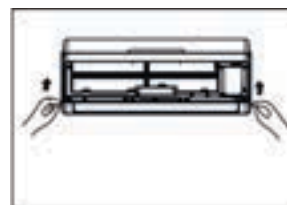

Manevrarea filtrului



Filtru de Împrospătare a aerului

Înainte de întreținere

- Opriți aparatul înainte de curățare. Pentru a curăța, ștergeți cu o cârpă moale, uscată. A nu se folosi înălbitor sau substanțe abrazive.

NOTĂ: Sursa de alimentare trebuie să fie deconectată înainte de a curăța unitatea interioară.

ATENȚIE

- O cârpă umezită cu apă rece poate fi folosită pe unitatea interioară, dacă este foarte murdară. Apoi ștergeți-o cu o cârpă uscată.
- Nu utilizați o cârpă tratată chimic sau aspirator de praf pentru a curăța aparatul.
- Nu folosiți benzină, diluant, praf de lustruire, sau solvenți similari pentru curățare. Acestea pot duce la spargerea sau deformarea suprafeței de plastic
- Niciodată nu folosiți apă fierbinte sau la o temperatură mai mare de 40 °C/104 °F pentru a curăța panelul frontal, ar putea provoca deformarea sau decolorarea acestuia.

Curățarea unității

Ștergeți unitatea numai cu o cârpă moale și uscată. În cazul în care aparatul este foarte murdar, ștergeți-l cu o cârpă înmuiată în apă caldă.

Curățarea filtrului de aer și a filtrului de împrospătare a aerului

Un filtru de aer infundat reduce eficiența de răcire a acestui echipament. Vă rugăm să curățați filtrul o dată la două săptămâni.

1. Ridicați panoul de la unitatea interioară până la un unghi când se oprește cu un semnal sonor de clic. Pentru unele modele, vă rugăm să folosiți barele de suspendare pentru a sprijini panoul
2. Apucați mânerul filtrului de aer și ridicați-l ușor să-l îndepărtați din suportul de filtru, apoi trageți-l în jos.
3. Scoateți filtrul de aer din unitatea interioară. Curățați filtrul de aer o dată la două săptămâni. Curățați filtrul de aer cu un aspirator sau cu apă, apoi se usucă în loc răcoros
4. Scoateți filtrul de împrospătare a aerului din rama de sprijin (disponibil doar pentru anumite modele)

- Curățați filtrul de împrospătare a aerului, cel puțin o dată pe lună, și înlocuiți-l la fiecare 4-5 luni.
- Curățați-l cu un aspirator, apoi se usucă la loc răcoros.



5. Instalați filtrul de împăspătare a aerului înapoi în poziție.
6. Introduceți partea superioară a filtrului de aer înapoi în unitate, având grijă ca marginile din stânga și din dreapta să se alinieze corect și plasați filtrul la loc în poziție

Înlocuirea filtrului de aer și filtrului de împăspătare a aerului

1. Scoateți filtrul de aer
2. Scoateți filtrul de împăspătare a aerului
3. Instalați un nou filtru de împăspătare a aerului.
4. Puneți la loc filtrul de aer și închideți ferm panelul frontal

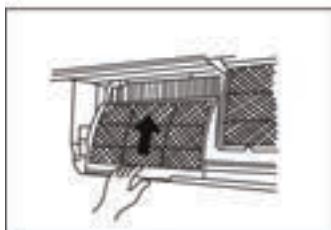

Pregătirea pentru perioade extinse de nefuncționare

Dacă aveți de gând să nu folosiți aparatul pentru o lungă perioadă de timp, efectuați următoarele:

- (1) Curățați unitatea interioară și filtrele
- (2) Lăsați să funcționeze ventilatorul aproximativ o jumătate de zi pentru a usca interiorul unității.
- (3) Opritiți aparatul de aer condiționat și deconectați-l de la priză
- (4) Scoateți bateriile din telecomandă. Unitatea exterioară necesită întreținere și curățare periodică. Nu încercați să faceți acest lucru singur. Contactați distribuitorul sau furnizorul de servicii

Verificarea de dinainte de sezon

- Verificați dacă cablajul nu este rupt sau deconectat
- Curățați unitatea interioară și filtrele
- Verificați dacă filtrul de aer este instalat
- Verificați dacă fanta de refulare a aerului sau dacă orificiul de intrare este blocat după ce instalația de aer condiționat nu a fost folosită pentru o perioadă lungă de timp.

⚠ ATENȚIE

- Nu atingeți părțile metalice ale unității când scoateți filtrul. Leziunile pot apărea la manipularea marginilor metalice ascuțite.
- Nu folosiți apă pentru a curăța în interiorul instalației de aer condiționat. Expunerea la apă poate distruge izolația, ceea ce duce la posibile șocuri electrice.
- Când curățați unitatea, în primul rând asigurați-vă că echipamentul este deconectat de la rețeaua electrică.
- Nu spălați filtrul de aer cu apă caldă la o temperatură mai mare de 40°C/104°F. Scuturați-l ferm de umiditate și uscați-l la umbră. Nu-l expuneți direct la soare, se poate micșora

Funcționarea normală a aparatului de aer condiționat

Următoarele evenimente pot apărea în timpul funcționării normale

1. Protecția aparatului de aer condiționat
 - Protecția compresorului
 - Compresorul nu repornește după 3 - 4 minute după ce s-a oprit
 - Împotriva aerului rece (numai pentru modelele cu funcție de răcire și încălzire)
 - Aparatul este conceput pentru a nu sufla aer rece în modul ÎNCĂLZIRE, atunci când schimbătorul de căldură din interior este în una din următoarele trei situații și temperatura setată nu a fost atinsă
 - A) Când încălzirea abia a început
 - B) Degivrare
 - C) Temperatura de încălzire scăzută
 - Ventilatorul unității interioare sau cel de la exterioră se va opri când se degivrează echipamentul (numai pentru modelele cu funcție de răcire și de încălzire)
 - Degivrare (numai pentru modelele cu funcție de răcire și de încălzire)
 - Gheața poate fi generată la unitatea externă când temperatura exterioară este scăzută și umiditatea a mare rezultând o eficiență scăzută a echipamentului de aer condiționat
 - În timpul acestei operațiuni echipamentul de aer condiționat se va opri din funcționare și va începe procesul de degivrare.
 - Timpul de dezghețare poate varia între 4 și 10 minute în funcție de temperatura exterioară și de cantitatea de gheață acumulată pe unitatea externă
2. O ceață de culoare albă care vine de la unitatea interioară
 - O ceață de culoare albă poate fi generată de diferența mare de temperatură dintre admisia și refularea aerului în Modul de Răcire, într-un mediu interior cu o umiditate ridicată
 - O ceață de culoare albă poate fi generată de procesul de degivrare, când echipamentul de aer condiționat repornește în Modul de Încălzire după ce a efectuat procesul de degivrare
3. Zgomot mic la echipamentul de aer condiționat
 - S-ar putea să auziți un sunet ca un mic fluierat atunci când compresorul este în funcțiune sau imediat după ce acesta s-a oprit. Este zgomotul produs de agentul frigorific care curge prin țevi până se oprește
 - Puteți auzi, de asemenea, un mic "scârțâit" atunci când compresorul este în funcțiune sau imediat după ce acesta s-a oprit. Acest lucru este cauzat de dilatarea sau contracția pieselor din plastic ale aparatului atunci când temperatura se schimbă.
 - Un zgomot poate fi auzit și din cauza flapsurilor care se mișcă înspre poziția inițială atunci când aparatul pornește.
4. Unitatea internă suflă aer amestecat cu praf

Acest lucru este normal atunci când aparatul de aer condiționat nu a mai fost folosit pentru o perioadă lungă de timp.
5. Un miros ciudat iese din unitatea interioară

Acest lucru este cauzat de unitatea interioară care eliberează mirosuri de materiale de construcții, de la mobilier sau fum.
6. Aparatul de aer condiționat trece în modul de VENTILARE din Modul de RĂCIRE sau ÎNCĂLZIRE (numai pentru modelele cu funcție de răcire și încălzire)

Când temperatura interioară atinge punctul setat de dvs, compresorul se va opri automat și echipamentul de aer condiționat trece automat în modul de VENTILARE. Compresorul va reporni când temperatura interioară crește (în Modul de Răcire) sau scade (în Modul de Încălzire) față de temperatura setată de dvs

7. Echipamentul de aer condiționat intră în funcția Anti-mucegai după oprire.

8. Poate picura apă de pe suprafața unității interne când aparatul funcționează în Modul de Răcire într-o încăpere cu umiditate ridicată (mai mare de 80%). Mutați flapsurile la poziția orizontală maximă și setați viteza MARE a ventilatorului.

9. Modul de Încălzire (pentru modelele cu funcție de Răcire și Încălzire)

Aparatul de aer condiționat atrage căldura de la unitatea exterioară și o eliberează prin unitatea interioară.

Când temperatura exterioară scade, căldura atrasă de la unitatea exterioară scade de asemenea. În același timp, încărcarea termică a aparatului de aer condiționat crește din cauza diferenței mari de temperatură dintre interior și exterior. În cazul în care o temperatură confortabilă, nu poate fi atinsă de către aparatul dvs de aer condiționat, vă sugerăm să folosiți auxiliar și un alt dispozitiv de încălzire.

10. Funcția de Auto Restart

- O întrerupere a energiei electrice va opri complet aparatul dvs de aer condiționat.
- Pentru unitățile fără funcția de Auto Restart, când se reia alimentarea cu energie electrică, ledul de la unitatea internă începe să pâlpâie. Apăsăți tasta PORNIT/OPRIT de pe telecomandă pentru a reporni echipamentul. Pentru unitățile dotate cu această funcție de Auto Restart când se reia alimentarea cu energie electrică, acestea vor reporni automat cu setările de dinainte de întreruperea alimentării cu energie electrică.

Ghid de depanare

| | |
|---|--|
| Dacă apare una din următoarele erori, opriți aparatul de aer condiționat, deconectați-l de la priză și conectați-l înapoi. Dacă problema persistă, deconectați-l iar de la priză și contactați cel mai apropiat centru service. | |
| Problemă | Ledul FUNCȚIONARE sau alt led indicator pâlpâie încontinuu. |
| | Siguranța se arde des sau circuitul electric se împușcă. |
| | Apă sau alte obiecte pătrund în unitate. |
| | Telecomanda nu funcționează sau funcționează anormal. |
| | Dacă apar unul din următoarele coduri pe afișajul unității: E0, E1, E2, E3... sau P0, P1, P2, P3... |

| Defecțiuni | Cauză | Ce ar trebui făcut? |
|--|--|--|
| Aparatul nu pornește | Pană de curent | Așteptați realimentarea cu energie electrică |
| | Unitatea s-ar putea să fie deconectată de la priză | Verificați dacă priza este bine fixată în perete |
| | Siguranța ar putea să fie arsă/sărită | Înlocuiți siguranța |
| | Bateriile din telecomandă ar putea să fie terminate | Înlocuiți bateriile |
| | Programarea făcută s-ar putea să fie incorectă | Așteptați sau anulați programarea aparatului |
| Aparatul nu răcește sau încălzește camera foarte bine (pentru modelele cu funcție de răcire și încălzire) | Setarea temperaturii necorespunzătoare | Setați corect temperatura. Pentru detalii, consultați manualul telecomenzii. |
| | Filtrul de aer este blocat | Curățați filtrul de aer |
| | Ferestre sau uși deschise | Închideți ferestrele și ușile |
| | Orificiile unității, de admisie sau refulare a aerului, sunt blocate | Deblocați orificiile și reporniți apoi aparatul |
| | Protecția compresorului de 3 minute s-a activat | Așteptați |
| În cazul în care problema nu a fost remediată, vă rugăm să contactați un dealer local sau cel mai apropiat centru de servicii pentru clienți. Asigurați-vă că informați cu privire la detaliile defecțiunii precum și modelul unității | | |

Notă: Nu încercați să reparați singur aparatul. Consultați mereu un service autorizat.